

# ENCYCLOPEDIA OF ANCHORING



B

## ANCHORS AND ANCHOR TOOLS

### SECTION B

[www.hubbellpowersystems.com](http://www.hubbellpowersystems.com)

E-mail: [hpsliterature@hubbell.com](mailto:hpsliterature@hubbell.com)

Phone: 573-682-5521 Fax: 573-682-8714

## Section B — Table of Contents

B-3	Power-Installed Screw Anchor (PISA®) Development
B-5	The Science of Selecting Anchors
B-6	Anchor Application Information (Soil Classification Data Chart)
B-7	Power-Installed Screw Anchors (Holding-Capacity/Installing-Torque Charts)
B-8	TOUGH ONE® Anchor Helix Assemblies - Small Hub (Torque Ratings: 10,000 ft.-lb. & 8,000 ft.-lb)
B-9	TOUGH ONE® Anchor Helix Assemblies - Large Hub (Torque Ratings: 15,000 ft.-lb. & 10,000 ft.-lb)
B-10	Standard & Mid-Strength PISA® Anchor Helix Assemblies 1 <sup>3</sup> / <sub>8</sub> "-Core (Torque Ratings: 4,000 ft.-lb. & 6,000 ft.-lb.)
B-11	PISA® 6 and PISA® 7 Anchor Helix Assemblies 1 <sup>1</sup> / <sub>2</sub> "-Core (Torque Ratings: 6,000 ft.-lb. & 7,000 ft.-lb.)
B-12	PISA® Anchor Rods, Eyenuts and Couplings
B-13	RR (Round-Shaft) Screw Anchors
B-14	SS (Square-Shaft) Screw Anchors
B-15	High-Strength SS Screw Anchors for Heavy Tension Loading
B-16 - 18	<u>Industry Standards for Multi-Helix Anchors</u>
B-19	No-Wrench Screw Anchors
B-20	“Bust” Expanding Anchors
B-21	Cross-Plate Anchors and Anchor Rod Extensions
B-22	Anchor Rods
B-23	Expanding Rock Anchors
B-24 - 25	Grouted Rock Anchors
B-26	Expanding Pole Key Anchors
B-27	Corrosion-Resistant Anchors
B-28	Bumper Posts
B-29	Pole Bearing Plates
B-30	Helical Pole Support
B-31 - 44	<u>Anchor Tool Catalog Selections</u>
B-45	<u>Application and Installation Guides:</u>
B-46	TOUGH ONE® Anchors
B-47	Standard PISA® Anchors
B-48	How to Use PISA® Anchors
B-49	Square Shaft and Round Rod Anchors
B-50	No Wrench Anchors
B-51	Corrosion Resistant Disk Anchors
B-52	8-Way Expanding (Bust) Anchors
B-53	Cross Plate Anchors
B-54	Pole Key Anchor
B-55	Expanding Rock Anchors
B-56	Bumper Post Anchors
B-57 - 61	How to Solve Anchor Problems
B-62 - 64	Tool Maintenance - Inspections
B-65 - 68	Anchor Tooling - Proper Maintenance
B-69 - 71	Anchor Installing Tool Safety - “Proper Tooling”
B-72 - 78	Tool Maintenance - “Detecting and Preventing Damaged Tooling”

# POWER-INSTALLED SCREW ANCHOR (PISA®) DEVELOPMENT



During 1959, after many years of engineering research and testing, Chance introduced a new system of utilizing the power of digging equipment to install screw anchors. The result was the first Chance Power Installed Screw Anchor (PISA®), the PISA® 4.

The system consists of a screw anchor, anchor rod and a special installing wrench. Each anchor has a galvanized steel threaded anchor rod with an upset hex; single or twin helices welded to a square steel hub by shielded arc electric weld, and a galvanized forged steel guy wire eye nut which is screwed to the anchor rod end.

With the anchor wrench attached to the Kelly bar or auger flight of the digger and with a locking dog arrangement holding the anchor rod in place, the PISA® anchor installs in eight to 10 minutes. The anchor may be installed with either 3½-foot rod or the standard seven-foot rod. A combination of either the 3½ or 7-foot rods may be used. Recommended maximum installing depth is 14-feet because tool recovery is difficult beyond this depth.

The early PISA® 4 anchor with its 1⅜-inch hub was limited to semi-plastic soils, so Chance engineers designed the PISA® 5 anchor with a 1½-inch hub for use in a greater cross-section of soils. Additional PISA® anchor designs followed, such as the PISA® 5-GT anchor and 7-GT anchor. Through Chance testing and close contact with utilities, the PISA® anchor family was expanded. Power-installed transmission anchors were introduced for high torque applications during the early 1960s. During 1980, Chance again advanced the science of anchoring by introducing 10,000 foot-pound anchor series called, "SQUARE ONE® anchors." Unlike previously introduced PISA® anchor designs, the high-strength SQUARE ONE® anchor series was driven by a wrench which slides into the hub of the anchor. The same drive wrench can be used to drive standard-strength and mid-strength series anchors. In 1990, Chance introduced the TOUGH ONE® family of 15,000 foot-pound anchors. TOUGH ONE® anchors were cast steel with no welds. The 1⅜-inch Chance installing wrench will install all Chance PISA® anchors to 10,000 foot pounds. For TOUGH ONE® anchor installations above 10,000 foot pounds, you will need the high-strength TOUGH ONE® wrench system from Chance.

Throughout the years, Chance engineers have conducted anchoring tests in conjunction with customer utilities. This has given customers a better opportunity to select the type of anchoring systems best suited to their particular needs. As a result, Chance anchors have earned an excellent reputation, making it possible for Chance to develop and improve new anchoring systems to meet the demands of utility companies throughout the world.

## SIDE-BY-SIDE TESTS REVEAL PISA'S CLEAR SUPERIORITY

The basic reason for installing an anchor is to provide a load-attachment point at ground line, so it is important that the anchor have the necessary holding capacity. Field tests have shown that screw anchors normally hold greater loads than larger-size expanding anchors. These examples underscore this point. The graphs represent an 8-way expanding anchor and a power-installed screw anchor tested where conditions — date, soil, location, installation, and test crew, etc. — were as nearly equal as possible.

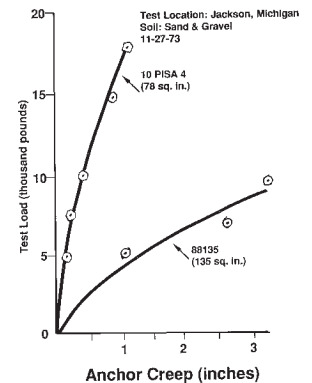

## PISA® Selection Guide For Replacing Popular Expanding & Cross Plate Anchor Designs

CHANCE CAT. NO OR DESCRIPTION	CHANCE SOIL CLASS				
	3	4	5	6	7
ULTIMATE ANCHOR HOLDING CAPACITY* - POUNDS					
88135 Expanding Anchor	26,500	22,000	18,500	15,000	10,000
X-16 Cross Plate Anchor	26,500	22,500	18,500	14,500	9,500
PISA® Which Will Provide Equal or Greater Holding Capacity	12" or 2-8" (1" Dia. Rod)	12" or 2-8" (¾" Dia. or Larger Rod)	12" or 2-8" (¾" Dia. or Larger Rod)	12" or 2-8" (⅝" Dia. or Larger Rod)	12" or 2-8" (⅝" Dia. or Larger Rod)

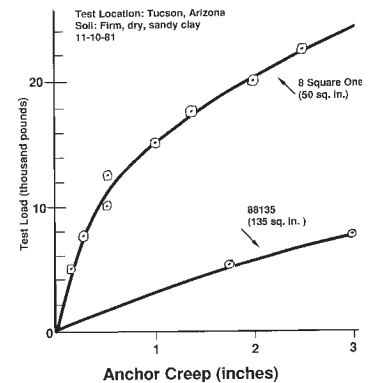

\* Predicted ultimate holding capacities are based on results of extensive Chance tests and interpretation and are offered as an application guide only. They do not represent a guarantee of holding capacity in a particular soil class. User must factor in his individual, appropriate safety factor.



# The Science of Selecting Anchors

## Soil Mechanics and Holding Capacity

During the early stages of the screw anchor, the load resistance of an installed anchor could not be predicted with reasonable accuracy. Specific information on soil conditions was lacking, making anchor selection more or less a guess. With little consideration for soil variations and the effects of seasonal weather changes or drainage, soils were classified as “sand, clay, hardpan or swamp.” There wasn’t any definitive explanation for such soil conditions.

Chance soil classification data opened new horizons in predicting anchor holding capacity. Initially, it was necessary to obtain soil samples from the projected anchor depth in order to classify the soil and to make anchor recommendations. However, this method was inconvenient, costly and time-consuming.



## Soil Probe, A Logical Development

Chance engineers developed the “soil test probe”, a mechanical tool which makes it possible to infer subsoil conditions from the surface of the earth. The soil test probe is screwed into the soil. As it displaces the soil, probe installation torque is measured in inch-pounds on a torque gauge, which is an integral part of the installing tool. Probe torque readings are then compared with the information on the Chance Soil Classification Data Chart and translated into the appropriate soil classification.

## PISA®: Power-Installed Screw Anchors

More than 50 years ago, Chance introduced this system of utilizing the power of digging equipment to install screw anchors. The system consists of a screw anchor, anchor rod and a special installing wrench. Each anchor has a galvanized steel threaded anchor rod with an upset hex; single or twin helices and a galvanized guy wire nut which is screwed to the anchor rod end. PISA anchors can be installed in a matter of minutes.



## Torque and Performance

Later this method was improved with the development of Chance torque indicators and sets of holding capacity values for given anchor types. This did not obviate the soil classification data but strengthened and simplified it so the utility employee could install a PISA® anchor or other Chance anchor to a given torque value and predict with relative accuracy the holding capacity of the installed anchor. Actually, the correlation between installing torque and anchor performance required thousands of tests throughout the United States and in every conceivable soil condition. It is much labor, engineering research and investment that have made possible the development of this reliable and predictable anchoring philosophy.

## Torque Ratings

Chance screw anchors are designed and manufactured for maximum torsional strength. During installation, some of the torque applied by the digger and measured by installation torque indicators is dissipated by friction along the wrench and not applied to the anchor itself, so it is possible to apply more torque than the anchor alone can withstand. Chance anchors are rated by maximum working torque or, for the more recent designs, by the 5 per cent exclusion limit which is a more explicitly defined criterion based on statistical analysis of on-line quality control testing. Both ratings take into consideration the variation to be expected in anchor torsional strength due to normal variations in materials and manufacturing processes. Customers should consider this variation along with the wide variation that can be seen in the frictional loss along the wrench in deciding how much torque can be applied safely during installation. The fact that Chance ratings are set near the minimum credible torsional strength also should be considered in comparing Chance ratings to those of manufacturers who rate their anchors based on average strength.

# Anchor Application Information

## SOIL CLASSIFICATION DATA

Class	Common Soil-Type Description	Geological Soil Classification	Probe Values in.-lb. (NM)	Typical Blow Count "N" per ASTM-D1586
0	Sound hard rock, unweathered	Granite, Basalt, Massive Limestone	N.A.	N.A.
1	Very dense and/or cemented sands; coarse gravel and cobbles	Caliche, (Nitrate-bearing gravel/rock),	750 - 1600 (85 - 181)	60-100+
2	Dense fine sands; very hard silts and clays (may be preloaded)	Basal till; boulder clay; caliche; weathered laminated rock	600-750 (68 - 85)	45-60
3	Dense sands and gravel; hard silts and clays	Glacial till; weathered shales, schist, gneiss and siltstone	500 - 600 (56 - 68)	35-50
4	Medium dense sand and gravel; very stiff to hard silts and clays	Glacial till; hardpan; marls	400 - 500 (45 - 56)	24-40
5	Medium dense coarse sands and sandy gravels; stiff to very stiff silts and clays	Saprolites, residual soils	300 - 400 (34 - 45)	14-25
6	Loose to medium dense fine to coarse sands to stiff clays and silts	Dense hydraulic fill; compacted fill; residual soils	200 - 300 (23 - 34)	7-14
**7	Loose fine sands; Alluvium; loess; medium - stiff and varied clays; fill	Flood plain soils; lake clays; adobe; gumbo, fill	100 - 200 (11 - 23)	4-8
**8	Peat, organic silts; inundated silts, fly ash very loose sands, very soft to soft clays	Miscellaneous fill, swamp marsh	less than 100 (0 - 11)	0-5

Class 1 soils are difficult to probe consistently and the ASTM blow count may be of questionable value.

\*\*It is advisable to install anchors deep enough, by the use of extensions, to penetrate a Class 5 or 6, underlying the Class 7 or 8 Soils.



# POWER-INSTALLED SCREW ANCHORS (PISA®)

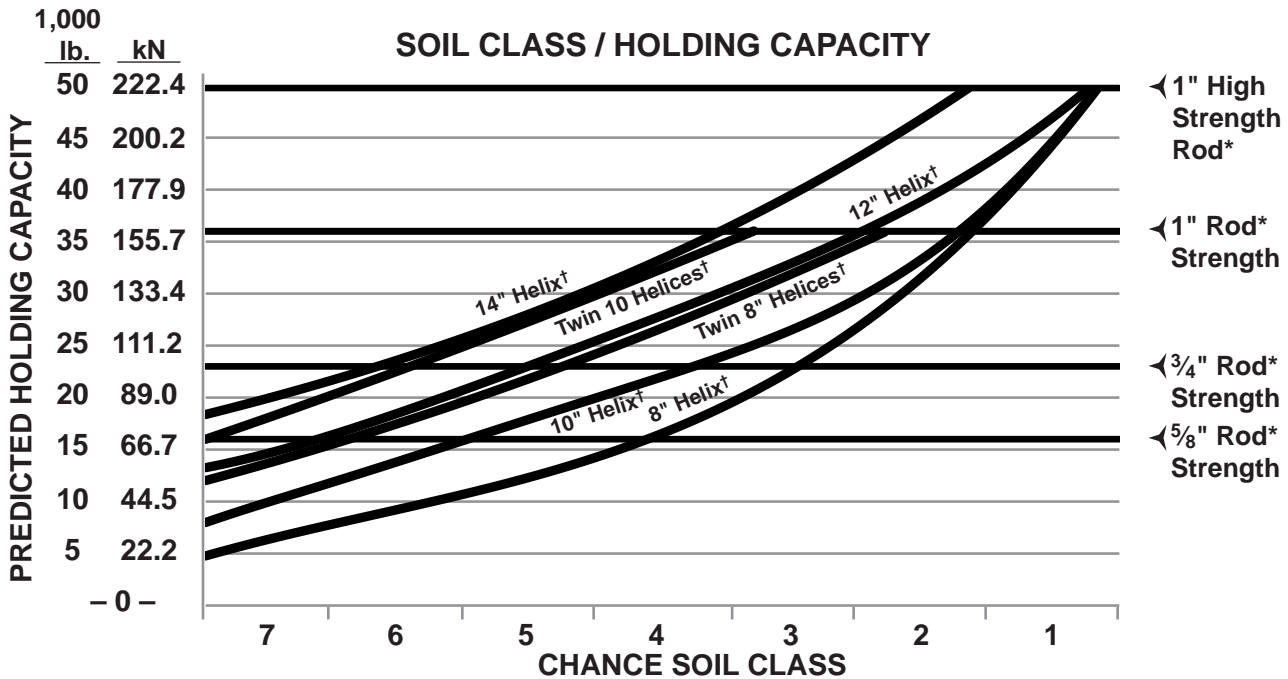

Under no circumstance should the rod and guy strand join at an angle of departure exceeding  $\pm 5^\circ$  on PISA anchors.

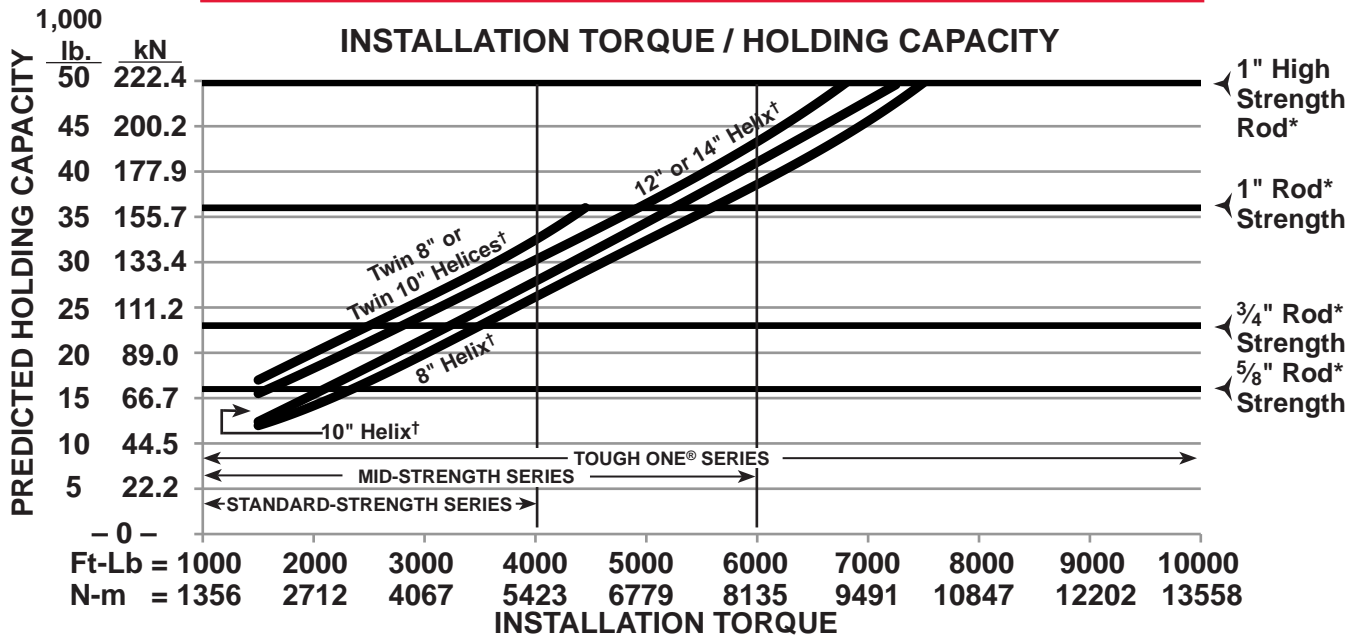

†Helix Diameters
8" = 203.2 mm
10" = 254.0 mm
12" = 304.8 mm
14" = 355.6 mm

*Rod Diameters	*Rod Strengths
5/8" (0.625") = 15.9 mm	16,000 lb. / 71.2 kN
3/4" (0.756") = 19.1 mm	23,000 lb. / 102.3 kN
1" = 25.4 mm	36,000 lb. / 160.1 kN
1" High Strength = 25.4 mm	50,000 lb. / 222.4 kN

Predicted ultimate holding capacities are based on results of extensive Chance tests and interpretation and are offered as an application guide only. They do not represent a guarantee of holding capacity in a particular soil class. A user must factor in his individual, appropriate safety factor. Torque values shown are steady values in homogenous soils, not peak values that might occur in non-homogenous soil. Torque values shown were obtained by averaging readings from the last 2 feet of anchor penetration. The anchor shaft must be aligned

with the guy load to prevent premature failure of the rod. Under no circumstance should the rod and guy strand join at an angle of departure exceeding  $\pm 5^\circ$  on PISA anchors.

CAUTION: ALL COMPONENTS OF THE CHANCE ANCHORING SYSTEM ARE PERFORMANCE MATED. USE OF OTHER ANCHORING PRODUCTS OR EQUIPMENT WILL NOT NECESSARILY PRODUCE THE SAME RESULTS.



# TOUGH ONE® ANCHOR HELIX ASSEMBLIES

TORQUE RATINGS: 10,000 FT.-LB., AND 8,000 FT.- LB.

## Small Hub (2¼" Square Inside)

The C10252-- series of TOUGH ONE® anchors have a smaller inside hub diameter than our C10250-- series. The smaller hub is designed to be installed with the Chance anchor wrench C1021583.

TOUGH ONE® anchors give users high-strength anchor capability in all soils. You get a better anchor at an economical price.

The anchor's sloped lead point improves penetration and helps soil flow from below the hub to above the anchor.

TOUGH ONE® anchors use standard PISA® rods (see page 4-10).

TOUGH ONE® anchors are painted with a black paint.

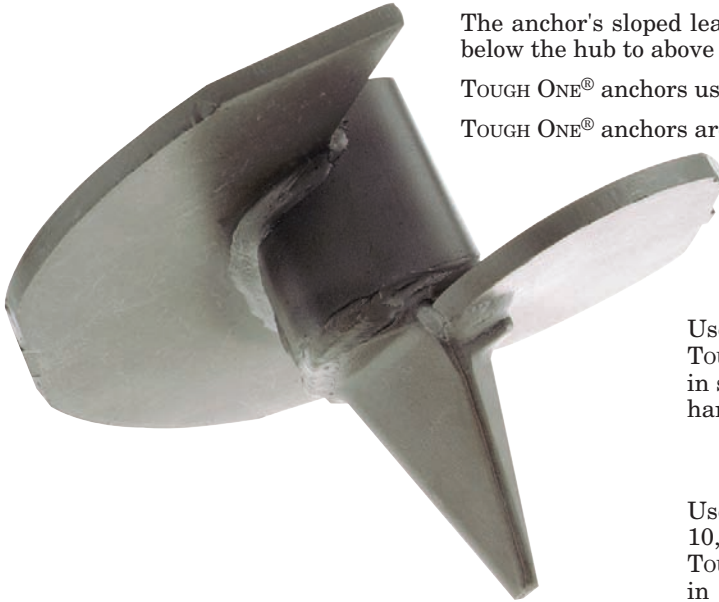

Use 8,000 ft.-lb.  
TOUGH ONE® anchor  
in soft and medium-  
hard soils

Use high-strength  
10,000 ft.-lb.  
TOUGH ONE® anchor  
in hard soils .

### Ordering Information 8,000 ft.-lb. TOUGH ONE® anchor 2¼" Square Inside Hub

Install with the Chance STANDARD (10,000 ft.-lb.) wrench (see page 4A-4).

	8" Dia.	Std. Pkg./ Pallet	10" dia.	Std. Pkg./ Pallet
For 5/8" dia. Rod	C1025208	4/144	C1025209	4/144
For 3/4" & 1" dia. Rods	C1025204	4/144	C1025205	4/144
	12" Dia.	Std. Pkg./ Pallet	14" dia.	Std. Pkg./ Pallet
For 3/4" & 1" dia. Rods	C1025206	2/72	C1025207	2/48
For 5/8" dia. Rods	C1025210	2/72		

### 10,000 ft.-lb. TOUGH ONE® anchor 2¼" Square Inside Hub

Install with the Chance STANDARD (10,000 ft.-lb.) wrench (see page 4A-4).

	8" Dia.	Std. Pkg./ Pallet	10" dia.	Std. Pkg./ Pallet
For 3/4" & 1" dia. Rods	C1025200	4/192	C1025201	4/144
	12" Dia.	Std. Pkg./ Pallet	14" dia.	Std. Pkg./ Pallet
	C1025202	2/72	C1025203	2/48



# TOUGH ONE® ANCHOR HELIX ASSEMBLIES

TORQUE RATINGS: 15,000 FT.-LB., AND 10,000 FT.- LB.

Large Hub (2½" Square Inside)



Use high-strength  
15,000 ft.-lb.  
Tough One in  
very hard soils  
short of solid rock.

TOUGH ONE® anchors give users high-strength anchor capability in all soils. You get a better anchor at an economical price. With TOUGH ONE® anchors, there's little concern about anchor breakage when encountering hard soils.

The anchor's sloped lead point improves penetration and helps soil flow from below the hub to above the anchor.

TOUGH ONE® anchors use standard PISA® rods (see page 4-10).

It's easy to upgrade your entire program with TOUGH ONE® anchors.

If soil conditions require installations above 10,000 ft.-lbs., you will need our TOUGH ONE® wrench system consisting of drive-end assembly, Kelly bar adapter and locking dog assembly. The high-strength system will also install PISA® 6 and 7 anchors. See page 4A-6 for high-strength anchor installing wrench information.

TOUGH ONE® anchors are painted with a black paint.



Use 10,000 ft.-lb.  
TOUGH ONE® anchor  
in soft and medium-hard soils.

## Ordering Information

### 10,000 ft.-lb. TOUGH ONE® anchor 2½" Square Inside Hub

Install with the Chance HYBRID\* or TOUGH ONE® wrench (see page 4A-4 or 4A-6)

For 5/8" dia. Rod For 3/4" & 1" Dia. Rods	8" Dia.	Std. Pkg./ Pallet	10" Dia.	Std. Pkg./ Pallet
	C1025008	4/144	C1025009	4/144
	C1025004	4/144	C1025005	4/144
For 5/8" dia. Rod For 3/4" & 1" dia. Rods	12" Dia.	Std. Pkg./ Pallet	14" Dia.	Std. Pkg./ Pallet
	C1025010	2/72	C1025007	2/48
	C1025006	2/72		

### 15,000 ft.-lb. TOUGH ONE® anchor 2½" Square Inside Hub

Install with only the Chance TOUGH ONE® wrench system (Catalog page 4A-6)

For 3/4" & 1" dia. Rods	8" Dia.	Std. Pkg./ Pallet	10" Dia.	Std. Pkg./ Pallet
	C1025000	4/144	C1025001	3/108
	12" Dia.	Std. Pkg./ Pallet	14" Dia.	Std. Pkg./ Pallet
	C1025002	2/72	C1025003	2/48

# PISA® ANCHOR HELIX ASSEMBLIES

Chance Standard-Strength 4,000 foot-pound anchors and Mid-Strength 6,000 foot-pound anchors have curvilinear leading edges to help penetrate rocky soils and to reduce damage during installation. These anchors are available in single and twin-helix designs. The same installing wrench installs Standard and Mid-Strength anchors as well as TOUGH ONE® C10252- - series anchors. See page 4A-4 for installing wrench information. Anchors are painted with a black paint.



PISA® anchor installation takes about 5 minutes with two workers.



## STANDARD-STRENGTH ANCHOR SERIES

1 3/8" CORE — 4000 ft.-lbs. Typical Working Torque — Squared Helix — 3.0" Helix Pitch

SINGLE HELIX	Catalog Number							
	8" Dia.	Std. Pkg./ Pallet	10" Dia.	Std. Pkg./ Pallet	12" Dia.	Std. Pkg./ Pallet	14" Dia.	Std. Pkg./ Pallet
For 5/8" Dia. Rods	024474	8/240	024476	4/96	024462*	4/80	NA	—
For 3/4" & 1" Dia. Rods	024475	8/240	024478	4/96	024481	4/80	024484*	2/32

\*RUS Accepted

TWIN HELIX	Catalog Number			
	8" Dia.	Std. Pkg./ Pallet	10" Dia.	Std. Pkg./ Pallet
For 3/4" & 1" Dia. Rods	012904	1/30	012905	1/30

## MID-STRENGTH ANCHOR SERIES

1 3/8" CORE — 6000 ft.-lbs. Typical Working Torque — Squared Helix — 3.0" Helix Pitch

SINGLE HELIX	Catalog Number							
	8" Dia.	Std. Pkg./ Pallet	10" Dia.	Std. Pkg./ Pallet	12" Dia.	Std. Pkg./ Pallet	14" Dia.	Std. Pkg./ Pallet
For 5/8" Dia. Rods	E1021629	8/240	E1021630	4/144	E1021631	4/96	NA	—
For 3/4" & 1" Dia. Rods	E1021632	8/240	E1021633	4/144	E1021634	4/96	E1021801	2/32

TWIN HELIX	Catalog Number					
	4" Dia.	Std. Pkg./ Pallet	8" Dia.	Std. Pkg./ Pallet	10" Dia.	Std. Pkg./ Pallet
For 3/4" & 1" Dia. Rods	E1021635	1/30	E1021636	1/30	E1021637	1/30

See Page 4-10 for ordering PISA anchor rods and eyenuts.

# PISA® 6 and PISA® 7 ANCHOR HELIX ASSEMBLIES

Chance PISA®-6 6000 foot-pound anchors and PISA®-7 7000 foot-pound anchors have curvilinear leading edges to help penetrate rocky soils and to reduce damage during installation. These anchors are available in single and twin-helix designs.

PISA®-6 and PISA®-7 anchors have a 1½" square solid core for added strength. See page 4A-4 or 4A-6 for information on the 1½" installing wrench.

Anchors are painted with a black paint.

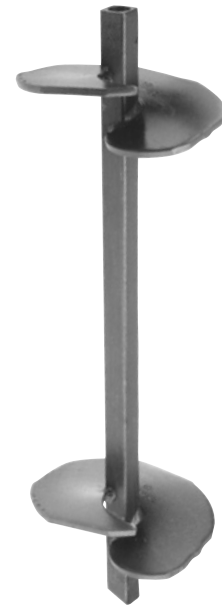

## PISA® 6 anchor

1½" CORE — 6000 ft.-lbs. Typical Working Torque — Squared Helix — 3.0" Helix Pitch

SINGLE HELIX	Catalog Number							
	8" Dia.	Std. Pkg./Pallet	10" Dia.	Std. Pkg./Pallet	12" Dia.	Std. Pkg./Pallet	14" Dia.	Std. Pkg./Pallet
For 5/8" Dia. Rods	E1020816	8/240	E1020817	4/144	—	—	—	—
For 3/4" & 1" Dia. Rods	E1020819	8/240	E1020820	4/144	E1020821	4/80	T1022142	2/32

TWIN HELIX	Catalog Number			
	Two 8" Dia.	Std. Pkg./Pallet	Two 10" Dia.	Std. Pkg./Pallet
For 3/4" & 1" Dia. Rods	E1020822	1/30	E1020823	1/30

## PISA® 7 anchor

1½" CORE — 7000 ft.-lbs. Typical Working Torque — Squared Helix — 3.0" Helix Pitch

SINGLE HELIX	Catalog Number							
	8" Dia.	Std. Pkg./Pallet	10" Dia.	Std. Pkg./Pallet	12" Dia.	Std. Pkg./Pallet	14" Dia.	Std. Pkg./Pallet
For 3/4" & 1" Dia. Rods	E1021223	8/240	E1020250	4/96	T1022143	4/80	T1022319	2/32

TWIN HELIX	Catalog Number					
	Two 8" Dia.	Std. Pkg./Pallet	Two 10" Dia.	Std. Pkg./Pallet	Two 4" Dia.	Std. Pkg./Pallet
For 3/4" & 1" Dia. Rods	E1021219	1/30	E1021220	1/30	V1021428	1/30

See Page 4-10 for ordering PISA anchor rods and eye nuts.

# PISA® ANCHOR RODS, EYENUTS & COUPLINGS

All components shown on this page are hot-dip galvanized per ASTM A153.



EYENUT	Catalog Number					
	Thimbleye®	Std. Pkg./Pallet	Twineye®	Std. Pkg./Pallet	Tripleye®	Std. Pkg./Pallet
For 5/8" Dia. Rods	12587*	25/2250	12589	25/1200	12593	25/750
For 3/4" & 1" Dia. Rods	6512*	25/1200	6562	25/1200	12585	25/1200
For 1" Dia. H.S.+	N/A	N/A	6562H	25/1200	12585H	25/1250

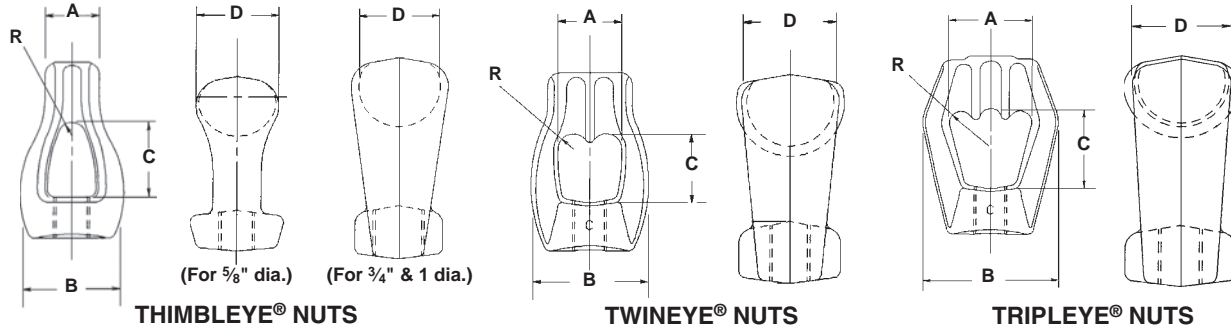

	A	B	C	D	R		A	B	C	D	R		A	B	C	D	R	
For 5/8" Dia. Rods	7/8"	1 7/8"	1 3/8"	1 11/64"	1/4"	For 5/8", 3/4" & 1 Dia. Rods	1 13/32"	2 25/64"	1 27/64"	1 1/2"	5/16"	For 5/8", 3/4" & 1 Dia. Rods	1 3/4"	2 13/16"	1 5/8"	1 1/2"	1/4"	
For 3/4" & 1 Dia. Rods	1 1/8"	2 25/64"	1 19/32"	1 5/8"	13/32"													

ROD	3 1/2-ft. ROD		7-ft. ROD		Ultimate Strength†
	Cat. No.	Std. Pkg./Pallet	Cat. No.	Std. Pkg./Pallet	
5/8" Dia.	12336P	5/50	12332P*	5/50	16,000 lbs.
3/4" Dia.	12634P	5/50	12632P*	5/50	23,000 lbs.
1" Dia.	12338P	5/50	12334P	1/50	36,000 lbs.
1" Dia. H.S.	C1021987	5/50	C1021986	2/50	50,000 lbs.

\*H.S. 50,000-lb. Eye nuts are galvanized and painted orange.

\*RUS Accepted.

†Ultimate strength ratings apply to properly installed anchors only. Failure to install within 5° of alignment with the guy load will significantly lower strength.

COUPLING	Catalog Number	Std. Pkg./Pallet
For 5/8" Dia. Rods	12245P	50/1950
For 3/4" & 1" Dia. Rods	12247P	50/2400

NOTE: Couplings are required only when it is necessary to add additional rods of 3 1/2 ft. or 7 ft. to form an extension.

Extension Rod & Coupling Combinations	3 1/2 ft. ROD		7 ft. ROD	
	Cat. No.	Std. Pkg./Pallet	Cat. No.	Std. Pkg./Pallet
5/8" Dia.	12249A	5/50	—	—
3/4" Dia.	12250A	5/50	C1022328	5/50
1" Dia.	12251A	5/50	12255A	2/50

## PISA® Rod & Eye Nut Combinations

Catalog No.	Rod, Eye Nut
E1020031	5/8" x 3 1/2' Rod & Thimbleye Nut
E1020047	5/8" x 3 1/2' Rod & Tripleye Nut
E1020035	5/8" x 7' Rod & Thimbleye Nut
E1020043	5/8" x 7' Rod & Twineye Nut
E1020051	5/8" x 7' Rod & Tripleye Nut
E1020032	3/4" x 3 1/2' Rod & Thimbleye Nut
E1020040	3/4" x 3 1/2' Rod & Twineye Nut
E1020036	3/4" x 7' Rod & Thimbleye Nut
E1020044	3/4" x 7' Rod & Twineye Nut
E1020052	3/4" x 7' Rod & Tripleye Nut
E1020041	1" x 3 1/2' Rod & Twineye Nut
E1020049	1" x 3 1/2' Rod & Tripleye Nut
E1020037	1" x 7' Rod & Thimbleye Nut
E1020045	1" x 7' Rod & Twineye Nut
E1020053	1" x 7' Rod & Tripleye Nut

## Corrosion-Protected PISA® Rod & Coupling

Rod is asphalt-coated galvanized with heat-shrink and plastic tube covering. Coupling is galvanized, covered with heat-shrink tubing.

Rod	Fits Rod Size	Std. Pkg./Pallet
Cat. No.		
C1021996	1" x 7"	2/50
C1022061	1" x 3 1/2'	5/50
Coupling		
Cat. No.		
C1025240	1"	50/2400



# RR (ROUND-ROD) SCREW ANCHORS

The Round-Rod "RR" multi-helix anchors are used in areas where weak soil conditions exist and moderate holding capacities are required. All helix lead sections are 7 ft. long. Extension shafts may be required for installation to proper depth.

RR screw anchors consist of three galvanized components: Lead section, extension shaft (which includes an integral coupling), and

the guy adapter. Each extension and guy adapter includes a high-strength bolt and nut.

Type RR (Round-Rod) anchors torque rating is 2,300 ft-lb. Ultimate tension rating for RR mechanical strength is 70,000 lb. Failure to install within 5° of alignment with the guy load will significantly lower strength.

## LEAD SECTIONS

Catalog No.	Length	Helix Combinations	Std. Pkg./Pallet	Holding Capacity - (lb.) vs. Soil Class		
				Class 7	Class 6	Class 5
012690AE	7 ft.	8" - 10"	1/20	19,000	23,000	27,000
012690AEJ	7 ft.	8" - 10" - 12"	1/20	26,000	32,000	39,000
V1090007	7 ft.	10" - 10" - 10"	1/15	25,000	31,000	N/A
V1090006	7 ft.	10"	1/20	17,000	21,000	24,000

## EXTENSIONS

Catalog No.	Nominal length	Std. Pkg./Pallet
12696	3½ ft.	1/50
12697	5 ft.	1/50
12698	7 ft.	1/30
12699	10 ft.	1/50

Extensions with helices are available. Contact your Hubbell representative or ServiCenter for information.

## GUY ADAPTERS: 18" overall length, 17" L<sub>3</sub> length

Catalog Number	WITHOUT Pulling Eye	WITH Pulling Eye	Strand Eye Rating*	Pulling Eye Rating	**Std. Package per Pallet
C1020023	Thimbleye®	N/A	70,000 lb	N/A	5/200
C1020024	N/A	Twineye®		12,000 lb	5/200
C1020025	N/A	Tripleye®		N/A	5/200
C1100041	Ovaleye	N/A		N/A	5/200

\*\*Guy adapters are shipped in corrugated cartons.

### TYPICAL "RR" DRIVE STRING

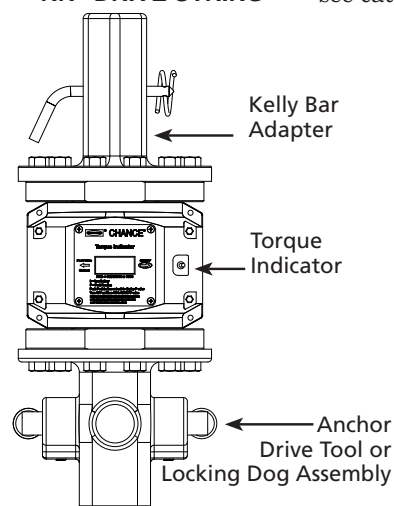

For installation tool options, see catalog Section 4A.

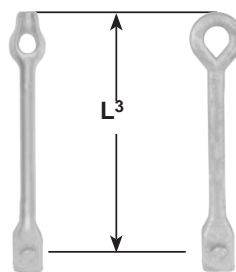

Thimbleye® & Ovaley Guy Adapters WITHOUT Pulling Eye

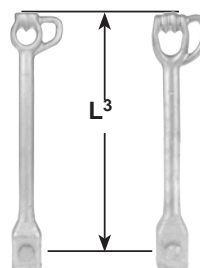

Twineye® & Tripleye® Guy Adapters WITH Pulling Eye

NOTE: Guy wire should not be attached to Pulling Eye.



Extension Lead Section

## LOAD CAPACITY<sup>1</sup> BASED ON INSTALLATION TORQUE<sup>2</sup> LOAD CAPACITY OF RR ANCHORS IN SOIL (POUNDS TENSION)

Helix Combinations	Installation Torque (ft-lb)		
	1,500	2,000	2,300
10"	16,000	22,000	28,000
8" - 10"	17,000	23,000	29,000
10" - 10" - 10"	19,000	25,000	31,000
8" - 10" - 12"	19,000	25,000	31,000

<sup>1</sup>Load capacities listed above are ultimate values based on average test data and are offered as an application guide. Typical deflection at ultimate load ranges between 2 and 4 inches. The listed values should be reduced by an appropriate factor of safety. More specific data on soils and anchor performance in any site condition can be obtained by contacting Hubbell Power Systems.

<sup>2</sup>The torque values shown are steady values in homogeneous soils, not peak values that can occur in non-homogeneous soils such as glacial till or other rocky soils. The torque values shown are obtained by averaging the readings from the last 2 feet of anchor penetration.



# SS5 (SQUARE-SHAFT) SCREW ANCHORS

Square-Shaft "SS" multi-helix screw anchors are designed for heavy-guy loading. They have 1½" square steel shafts. Extension shafts must be coupled to the helix section for installation to the proper depth. For installation tool options, see catalog Section 4A.

SS screw anchors consist of three galvanized components: the lead section, the extension shaft, which includes an integral coupling, and the guy adapter. Extensions and guy adapters include a high-strength bolt and nut.

## LEAD SECTIONS

Catalog No.	Length	Helix Combinations	†Std. Pkg./Pallet	¹Holding Capacity - (lb.) vs. Soil Class					
				Class 7	Class 6	Class 5	Class 4	Class 3	Class 2
012642AE*	3 ft.	8" - 10"	1/20	19,000	23,000	27,000	32,000	36,000	41,000
012642EJ	3½ ft.	10" - 12"	1/20	21,000	26,000	31,000	36,000	41,000	46,000
012642AEJ*	5½ ft.	8" - 10" - 12"	1/20	26,000	32,000	39,000	46,000	51,000	58,000
012642EJN*	7 ft.	10" - 12" - 14"	1/20	29,000	37,000	45,000	53,000	61,000	69,000
012642AEJN	10½ ft.	8" - 10" - 12" - 14"	1/20	31,000	40,000	49,000	58,000	67,000	N/A
012642EJNS*	10½ ft.	10" - 12" - 14" - 14"	1/20	40,000	51,000	62,000	70,000	N/A	N/A

Mechanical Properties	SS5 1.50" Square Shaft
Max. Installation Torque	5,500 ft.-lb.
Min. Ultimate Tension Strength	70,000 lb.

\*RUS Accepted. †Lead sections are banded to wood blocks to facilitate forklift handling.

## EXTENSIONS

Catalog No.	Nominal Length	Helix Diameter	†Std. Pkg./Pallet
12655	3½ ft.	N/A	1/50
12656	5 ft.	N/A	1/50
12657	7 ft.	N/A	1/40
12658	10 ft.	N/A	1/30
12656N	5 ft.	14"	1/20
12655J	3½ ft.	12"	1/20

## EXTRA BOLT & NUT for Extensions & Guy Adapters

Catalog No.	Description
P0010041P	Extra SS5 Bolt
055449P	Extra SS5 Nut

## GUY ADAPTERS: 18" overall length, 17" L<sub>3</sub> length

Catalog Number	WITHOUT Pulling Eye	WITH Pulling Eye	Strand Eye Rating*	Pulling Eye Rating	††Std. Package per Pallet
C1020023	Thimbleye®	N/A	70,000 lb	N/A	5/200
C1020024	N/A	Twineye®		12,000 lb	5/200
C1020025	N/A	Tripleye®		N/A	5/200
C1100041	Ovaleye	N/A		N/A	5/200

††Guy adapters are shipped in corrugated cartons.

## LEAD SECTION & GUY ADAPTER COMBINATIONS\*

Catalog No.	Guy Adapter	Helix Combinations
126541AE	THIMBLEYE® without Pulling Eye	8" - 10"
126541EJ	THIMBLEYE® without Pulling Eye	10" - 12"
126541AEJ	THIMBLEYE® without Pulling Eye	8" - 10" - 12"
126541EJN	THIMBLEYE® without Pulling Eye	10" - 12" - 14"
126541EJNS	THIMBLEYE® without Pulling Eye	10" - 12" - 14" - 14"
126542AE	TWINEYE® with Pulling Eye	8" - 10"
126542EJ	TWINEYE® with Pulling Eye	10" - 12"
126542AEJ	TWINEYE® with Pulling Eye	8" - 10" - 12"
126542EJN	TWINEYE® with Pulling Eye	10" - 12" - 14"
126542EJNS	TWINEYE® with Pulling Eye	10" - 12" - 14" - 14"
126543AE	TRIPLEYE® with Pulling Eye	8" - 10"
126543EJ	TRIPLEYE® with Pulling Eye	10" - 12"
126543AEJ	TRIPLEYE® with Pulling Eye	8" - 10" - 12"
126543EJN	TRIPLEYE® with Pulling Eye	10" - 12" - 14"
126543EJNS	TRIPLEYE® with Pulling Eye	10" - 12" - 14" - 14"

\*Packaging note: Lead sections are banded to wood blocks to facilitate forklift handling. Guy adapters are shipped in separate corrugated cartons.

## LOAD CAPACITY<sup>1</sup> BASED ON INSTALLATION TORQUE<sup>2</sup> LOAD CAPACITY OF SS ANCHORS IN SOIL (POUNDS TENSION)

Catalog No.	Length	Helix Combinations	Installation Torque (ft.-lb)								
			1,500	2,000	2,500	3,000	3,500	4,000	4,500	5,000	5,500
012642AE*	3 ft.	8" - 10"	17,000	23,000	29,000	34,000	40,000	46,000	52,000	58,000	63,000
012642EJ	3½ ft.	10" - 12"	18,000	24,000	30,000	36,000	42,000	48,000	54,000	60,000	66,000
012642AEJ*	5½ ft.	8" - 10" - 12"	19,000	25,000	31,000	38,000	44,000	50,000	56,000	62,000	68,000
012642EJN*	7 ft.	10" - 12" - 14"	20,000	26,000	32,000	39,000	46,000	52,000	58,000	65,000	70,000
012642AEJN	10½ ft.	8" - 10" - 12" - 14"	20,000	27,000	34,000	40,000	47,000	54,000	61,000	68,000	70,000
012642EJNS*	10½ ft.	10" - 12" - 14" - 14"	21,000	28,000	35,000	42,000	49,000	56,000	63,000	70,000	70,000

<sup>1</sup>Holding capacities are based on average test data and are offered as an application guide only. Ultimate strength ratings apply to properly installed anchors only. Failure to install within 5° of alignment with the guy load will significantly lower strength. Load capacities listed above are ultimate values based on average test data and are offered as an application guide. Typical deflection at ultimate load ranges between 2 and 4 inches. The listed values should be reduced by an appropriate factor of safety. Minimum vertical depth is five times the diameter of the largest helix. More specific data on soils and anchor performance in any site condition can be obtained by contacting Hubbell Power Systems.

<sup>2</sup>The torque values shown are steady values in homogeneous soils, not peak values that can occur in non-homogeneous soils such as glacial till or other rocky soils. The torque values shown are obtained by averaging the readings from the last 2 feet of anchor penetration.

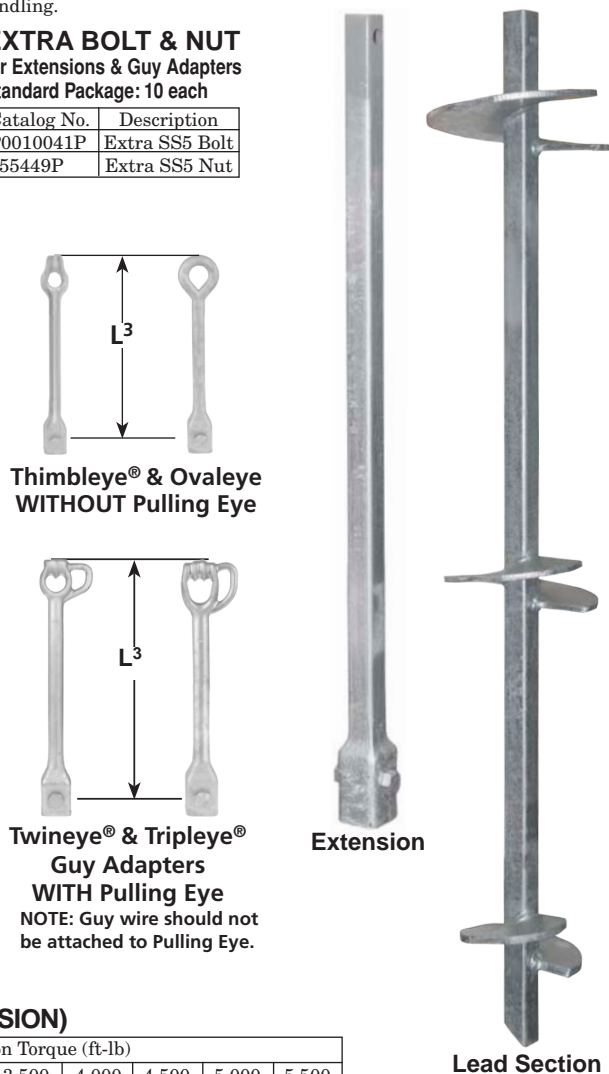

B

# HIGH-STRENGTH SS ANCHORS for Heavy Tension Loading

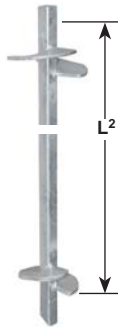

Lead Section

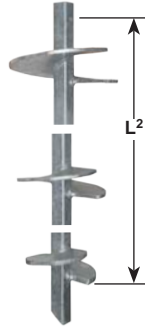

Lead Section

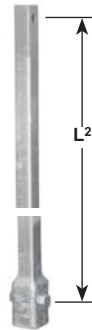

Plain Extension

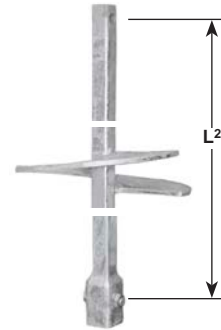

Single Helix  
Extension

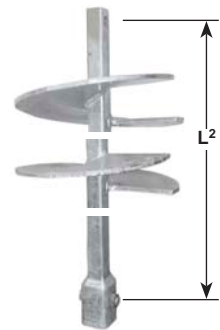

Two Helix  
Extension

## Guy Adapters

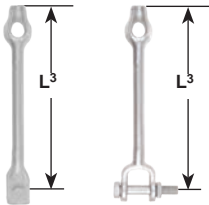

Socket \*Clevis  
THIMBLEYE®  
NO Pulling Eye

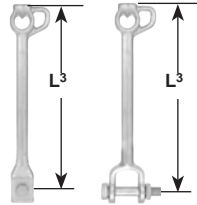

Socket \*Clevis  
TWINEYE®  
with Pulling Eye

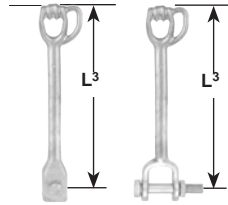

Socket \*Clevis  
TRIPLEYE®  
with Pulling Eye

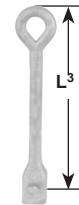

Ovaley  
Adapter  
NO Pulling Eye

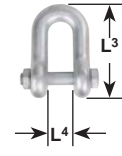

Chain  
Shackle

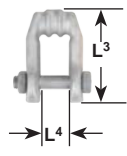

TRIPLEYE®  
Chain  
Shackle

## RATINGS

Mechanical Properties	SS 150 1.50" Square Shaft	SS 175 1.75" Square Shaft	SS 200 2.00" Square Shaft	SS 225 2.25" Square Shaft
Max. Installation Torque	7,000 ft.-lb.	10,500 ft.-lb.	16,000 ft.-lb.	23,000 ft.-lb.
Min. Ultimate Tension Strength	70,000 lb.	100,000 lb.	150,000 lb.	200,000 lb.

## LEAD SECTIONS – Hot-dip galvanized

Helix Configuration	Catalog No.	L¹	Catalog No.	L¹	Catalog No.	L¹	Catalog No.	L¹
8" & 10"	C1100385	30"	C1100227	30"	—	—	—	—
10" & 12"	C1100871	42"	C1100884	58"	—	—	—	—
6", 8" & 10"	—	—	—	—	C1100569	60"	C1100543	54"
8", 10" & 12"	C1100386	57"	C1100235	60"	C1100570	60"	C1100544	75"
10", 12" & 14"	C1100838	84"	C1100923	84"	C1100791	84"	—	—
14", 14" & 14"	C1100504	120"	C1100505	124"	C1100572	122"	C1100545	114"
8", 10", 12" & 14"	T1100521	—	C1100247	124"	C1100573	122"	C1100591	115"

## EXTENSIONS – Hot-dip galvanized

Helix Configuration	Catalog No.	L²	Catalog No.	L²	Catalog No.	L²	Catalog No.	L²
None	C1100388	37"	C1100136	37"	C1100563	37"	C1100645	33"
None	C1100470	59"	C1100137	59"	C1100564	58"	C1100646	60"
None	C1100389	80"	C1100138	80"	C1100565	80"	C1100647	80"
None	C1100440	122"	C1100140	124"	C1100566	123"	—	120"
Single 14" helix	C1100471	48"	C1100472	48"	C1100577	45"	C1100650	39"
Twin 14" helices	C1100454	80"	C1100450	80"	C1100581	80"	C1100652	78"
Triple 14" helices	C1100475	123"	C1100476	124"	C1100586	123"	—	120"

## EXTRA BOLT & NUT – Hot-dip galvanized – for Extensions and Guy Adapters (socket & clevis types) Standard Package: 10 each

Description	Catalog No.	Catalog No.	Catalog No.	Catalog No.
Extra Bolt – <b>Extension</b>	P0010041P	P0011443P	P0011445P	P0011771P
Extra Bolt – <b>Adapter</b>	P0010041P	P0011444P	P0010690P	—
Extra Nut – <b>BOTH</b>	055449P	055591P	P0010030P	056292P

## GUY ADAPTERS – Hot-dip galvanized – Socket & Clevis adapters: 18" overall length

Description	Cat No.	NOTES	L³	Cat. No.	NOTES	L³	Cat. No.	NOTES	L³	Cat. No.	NOTES	L³
Thimbleye No Pulling Eye	C1020023	—	17"	*T1100311	—	17"	*T1100312	—	17"	—	—	—
Twineye with Pulling Eye	C1020024	—	17"	*T1100964	—	17"	—	—	—	—	—	—
Tripleye with Pulling Eye	C1020025	—	17"	*T1100465	—	17"	*T1100629	—	17"	—	—	—
Ovaley No Pulling Eye	C1100041	—	17"	—	—	—	—	—	—	—	—	—
Chain Shackle	†C1100574	L⁴=1½"	5½"	T1100134	L⁴=1 13/16"	6 9/8"	C1100557	L⁴=2¼"	8¼"	C1100558	L⁴=2 3/8"	9"

†TRIPLEYE® shackle

\*Clevis fitting. Others have Socket fitting.

‡Rated at 70,000 lb.

# Industry Standards

based on CHANCE®  
multi-helix anchor specs

State-of-the-Art:

*R&D history of inter-helix spacing  
traces application of technical principles*



The helical screw anchor is not a sophisticated product in the 21st century of cell phones, the Internet and High-Definition TV. A low-tech product in a high-tech world, it continues to serve ever-expanding roles for utilities and in civil construction. In fact, the screw anchor's elegant simplicity is its greatest asset: An uncomplicated product with multiple uses.

## Historical Perspective: Low-tech to high-tech designs

Helical screw anchors may be simple in concept, but they come in many forms. Take out your copy of the CHANCE® *Encyclopedia of Anchoring* and look through the Anchor Product Section. It shows you these types: PISA® (Power Installed Screw Anchors), Tough One®, Square-Shaft (or SS), Round-Rod (or RR), and No-Wrench screw anchors. If you also have an Chance Civil Construction SA Catalog, you can find Types HS, T/C, Street Light Foundations (SLF), Area Lighting Foundations (ALF), and HELICAL PULLDOWN™ Micropiles (HPM). These anchor types all have three things in common:

1. At least one helically shaped bearing plate,
2. A central steel shaft,
3. An appropriate structural connection at the top.

Yet each different anchor type serves different applications. And new uses seemingly come to light every day.

## Answers to FAQs

### (Frequently Asked Questions):

This array of screw anchor types has led many to ask why so many? What requirements or design constraints have led to their current forms? Can the current design be improved?

In the case of multi-helix screw anchors, particularly Type SS, how far apart should the helix plates be spaced along the shaft?

Is there an optimum spacing that provides the best performance in terms of installation and load carrying capacity? Answering these questions requires looking back over some 40 years to just before Chance developed Type SS screw anchors.

Introduced in 1959, PISA anchors were well known and in widespread use by the early 1960's. They were available in single and twin-helix configurations (twin 8" and twin 10"). Their inter-helix spacing changed often over the years, but always has been in the 15- to 30-inch range. Their standard rod length was 7 ft. As the following quote from the 1966 edition of the *Encyclopedia of Anchoring* indicates, the chief advantage of multi-helix anchors was already known: "Installed in place of larger single helix Type PISA. Higher holding powers can be obtained with the two helix anchors."

Where two helices are better than one, logic indicates three or more helices would be better than two. This reasoning was put to good use in 1961, when Chance developed extendable Type RR multi-helix anchors. The original application for multi-helix RR anchors was as tiedowns for underground pipelines in poor soil conditions along coastal regions of the Gulf of Mexico. Type RR anchors worked well





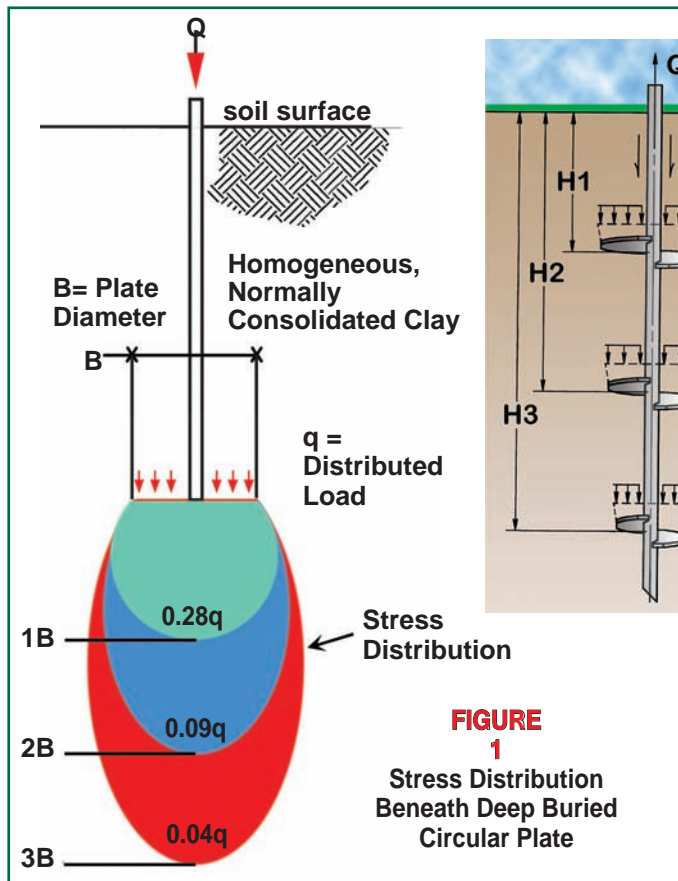

in weak surficial soils, but their 1¼” diameter shaft did not provide enough torque strength to penetrate very far into firm bearing soils.

Development of a high torque multi-helix anchor began in 1963, culminating in Chance’s introduction of Type SS 1½” square shaft multi-helix anchors in 1964-65.

Inter-helix spacing was 36” for both Types RR and SS anchors. Why 36 inches? Remember that the 7-ft. length of standard PISA rods was established as a length for a worker to reach when using the wrench-driven PISA system. Since Types RR and SS anchors also were driven by tooling attached to a torque motor, this same practical length applied to them as well.

Based on proportion, three helices equally spaced 36” apart fit well on a 7’-0” shaft. Using the same 36” spacing, two helices were placed on a 5’-0” shaft (for bed-mounted diggers) and four helices were placed on a 10’-0” shaft. The three helix configuration quickly became the most popular Type SS lead section and remains so today. Three-foot (36”) spacing remained the norm for Types RR and SS, as well as for HS-8, HS-11, and HS-14 High-Strength guy anchors developed later in the 1960s.

### Geotechnical science evolves changes

In the 1970s and early 1980s, a gradual change in the design philosophy at Chance eventually led to changes in inter-helix spacing. Adopting generally accepted geotechnical engineering principles, it was recognized that a deep buried plate (i.e., screw anchor helix) transferred an applied load to the soil in end bearing (bearing capacity

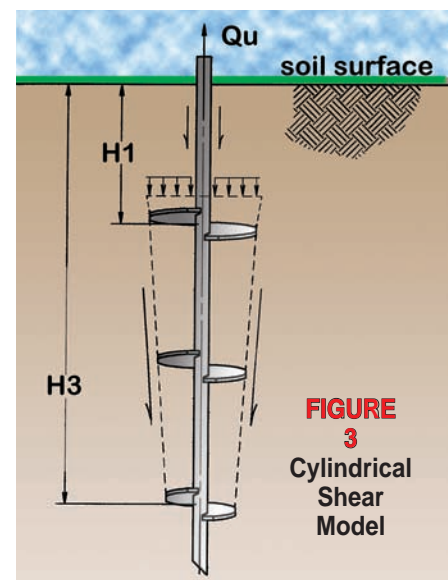
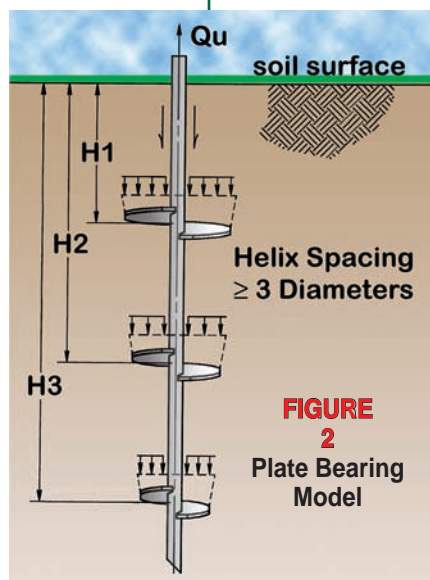

theory).

This transfer of load results in a “stress zone” within a defined soil volume immediately above or below the helix depending on the direction of the load (tension - above helix, compression - below helix). A necessary condition for this method to work is that the helices must be spaced far enough apart to avoid overlapping their stress zones.

The Boussinesq (circa 1885) Equation has described the stress distribution in soil resulting from a load applied via a buried plate/footing as shown in Figure 1. For a multi-helix anchor installed into uniform, homogeneous soil, spacing helix plates too close together can result in overlapping stress distributions, which may lead to unexpected failure.

Likewise, spacing helix plates too far apart prevents soil stress overlap, but results in a screw anchor that is unnecessarily long. As can be seen in Figure 1, the magnitude of stress one diameter away from the buried plate is 28% the magnitude of stress at the plate. Note the magnitude of stress three diameters away from the buried plate is only 4% the magnitude of stress at the plate. Greater distance from the plate results in stress magnitude reduction, but at a significantly reduced rate.

### What inter-helix spacing is optimum?

The **Boussinesq Equation** suggests a spacing of three-helix diameters as a practical solution based on stress distribution. The design question posed by the above discussion also has been answered by two other accepted principles.

The **bearing capacity theory** (Figure 2, plate bearing model) suggests the capacity of a multi-helix screw anchor is equal to the sum of the capacities of the individual helix plates. Calculating the unit bearing capacity of the soil and multiplying by the individual helix areas determine the total end-bearing capacity.

The cylindrical shear theory (Figure 3, cylindrical shear model) suggests the capacity of a multi-helix screw anchor is equal to the bearing capacity of the top-most helix (tension load), plus the friction capacity resulting from the shear strength of the soil along a cylinder bounded by the top and bottom helix with a diameter defined by the average of all helix diameters on a multi-helix anchor.

Both cylindrical shear and individual bearing represent permissible failure mechanisms for any inter-helix spacing, therefore the ultimate capacity associated with them are upper bounds of the actual ultimate capacity at all spacings (see Figure 4). At “small” spacings, cylindrical shear is the least upper bound and controls capacity, per the Least Upper-Bound Theorem. At “large” spacings, individual bearing becomes the least upper bound and controls capacity.

To determine where the transition occurs from cylindrical shear to individual bearing, data from late 1970’s field tests were analyzed. The interpreted results indicate that the transition spacing is about three diameters, as is indicated in Figure 4. This is consistent with the performance of multi-belled concrete piers (Bassett, 1977) and with the fact that the cylindrical shear and individual bearing methods usually give similar results for screw anchors with three-helix diameters spacing.

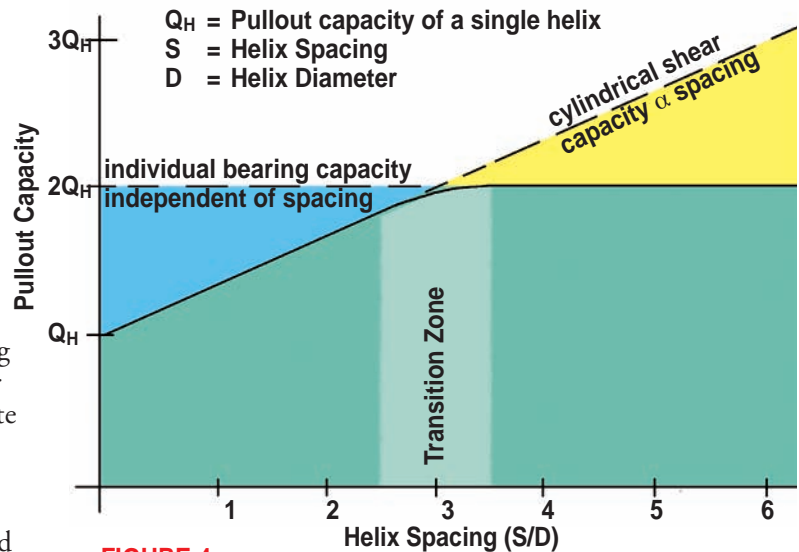

**FIGURE 4**  
**Pullout Capacity of 2-Helix Anchor vs Helix Spacing**

### Industry Standard derived from CHANCE® three-diameters spacing

It is important to understand that soils generally are not homogeneous mixtures exhibiting uniform strength properties. Spacing helix plates unnecessarily far apart increases the possibility that one or more of them will

not be located in the same soil layer as the others.

## ***The key is to space the helix plates just far enough apart to maximize the bearing capacity of a given soil.***

This works to reduce the overall length of the anchor and increases the likelihood for all helix plates to be located in the same soil layer. This leads to more predictable torque-to-capacity relationships and better creep (movement under load) characteristics.

Today, Chance manufactures helical screw anchors with three-helix-diameters spacing, the space between any

two helices being three times the diameter of the lower helix. This is the optimum spacing that historically has been sufficient to prevent one helix from significantly influencing the performance of another, while at the same time preventing the previously mentioned disadvantages of spacing helices too far apart.

## **INDUSTRY STANDARD**

**A Definition: Three-helix-diameter spacing –**  
***The optimum space between any two helical plates on a screw anchor is three times the diameter of the lower helix.***

With the introduction of Chance Type SS150, SS175, SS200, and SS225 High Strength SS Anchors in the late 1970’s and early 1980’s, helix plates were located on the shaft using three-helix-diameters spacing. Type HS anchors were changed to this spacing in 1986. The standard-strength SS, known as the SS5 series, remained at 36 inch spacing until 1997, when it also was updated to the industry standard of three-diameters spacing, now common to other Chance shaft-driven multi-helix screw anchors. ■

# NO-WRENCH SCREW ANCHOR

## • For Hand or Machine Installation

Chance No-Wrench Screw Anchors may be installed by hand or machine. The THIMBLEYE® eye or TRIPLEYE® eye on the rod has a large opening to admit a turning bar for screwing the anchor down. The eye will also fit into an adapter available from most hole-boring machine manufacturers so the anchor may be power-installed. The No-Wrench Screw Anchor consists of a drop-forged steel THIMBLEYE® eye or TRIPLEYE® eye rod welded to a steel helix. The entire anchor is hot-dip galvanized for long resistance to rust.

No-Wrench Screw Anchors can be installed to a greater depth to reach a firmer soil by using an extension rod. Maximum installing torque is 2300 ft.-lbs. for 1¼" diameter rod.

Catalog numbers 4345, 6346 and PS816 may be ordered with a forged THIMBLEYE® rod rather than the standard TRIPLEYE® rod. To order a THIMBLEYE® rod simply add "1" to the suffix of the catalog number. Example: Catalog No. 63461.

Typical working torque:  
 ¾" Rod 400 ft.-lbs.  
 1" Rod 1000 ft.-lbs.  
 1¼" Rod 2300 ft.-lbs.

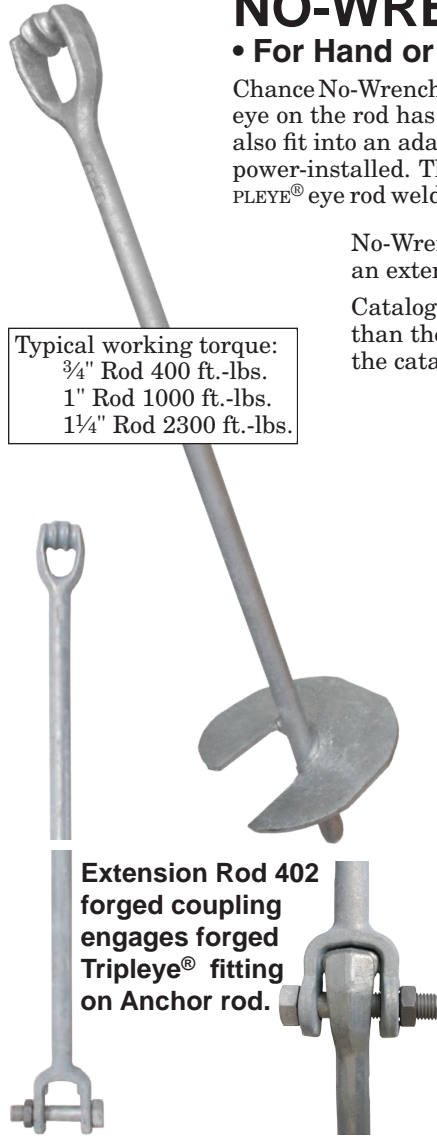

Extension Rod 402 forged coupling engages forged Tripleye® fitting on Anchor rod.

## APPLICATION AND ORDERING INFORMATION

Catalog No.	Description	Anchor Size Dia.	Rod Dia. & Length	Std. Pkg./Pallet	No-Wrench Screw Anchor Holding Capacity - (lbs.) vs Soil Class		
					Class 5	Class 6	Class 7
4345	TRIPLEYE®	4"	¾" x 54"	1/100	4500	3000	1500
6346*	TRIPLEYE®	6"	¾" x 66"	1/100	6500	5000	2500
PS816	TRIPLEYE®	8"	1" x 66"	1/60	11000	9000	6000
10146	TRIPLEYE®	10"	1¼" x 66"	1/20	13000	10000	7000
10148	TRIPLEYE®	10"	1¼" x 96"	1/20	13000	10000	7000
12537	TRIPLEYE®	14"	1¼" x 96"	1/20	16000	15000	12000
15148	TRIPLEYE®	15"	1¼" x 96"	1/20	19000	17000	14000
43451	THIMBLEYE®	4"	¾" x 54"	1/100	4500	3000	1500
63461	THIMBLEYE®	6"	¾" x 66"	1/100	6500	5000	2500
8161	THIMBLEYE®	8"	1" x 66"	1/60	11000	9000	6000

\*RUS Accepted.

### Extension Rod

Catalog No.	Description	Anchor Size Dia.	Rod Dia. & Length	Std. Pkg./Pallet	Class 5	Class 6	Class 7
402	TRIPLEYE®	N/A	1¼" x 72"	1/50	N/A	N/A	N/A

Note: If hand installed, holding capacity may be reduced by as much as 10% to 20%. Capacity ratings apply to properly installed anchors only.

Failure to install within 5° of alignment with the guy load will significantly lower strength.

# NO-WRENCH POWER INSTALLATION TOOL

## "NO WRENCH" TYPICAL DRIVE STRING

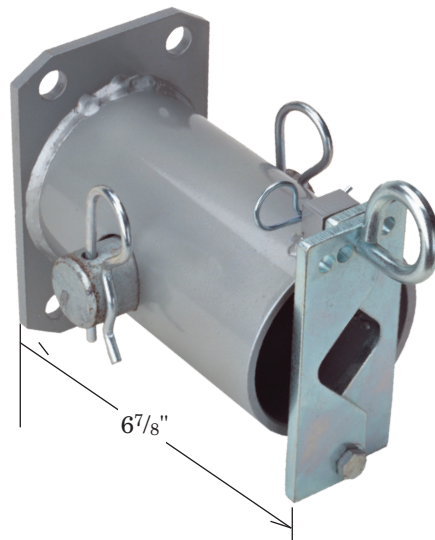
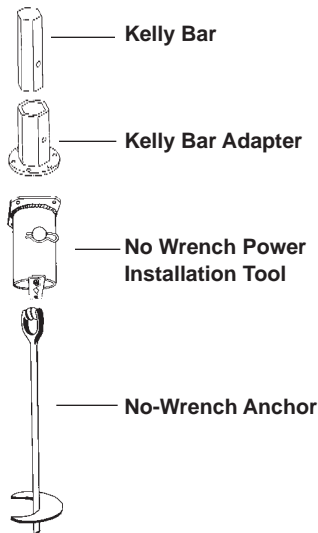

Catalog No.	Weight, lbs.
E3030255	9

This tool bolts directly to the installer's output flange or appropriate Kelly bar adapter. Adjustable pivot plates accept rods from ¾" to 1¼" diameter. Through-pin with retainer clip passes through the eyenut.

Has (four) holes on a 5¼" bolt circle for attachment. Includes (four) ½" x 1½" bolts, nuts and lockwasher.

Note: Can be attached to any Chance Torque Indicator

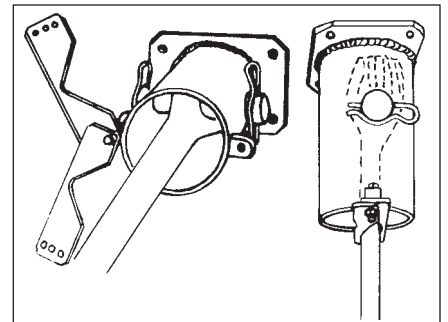

# “Bust” Expanding Anchor



## MORE HOLDING CAPACITY FOR LESS

Four different sizes are available with holding capacity as high as 40,000 pounds.

Chance “Bust” Expanding Anchors expand to take full advantage of the available area. All eight blades wedge into undisturbed earth . . . there is no wasted space between blades.

This anchor should be installed in relatively dry and solid soils. The effectiveness of the anchor is dependent upon the thoroughness of backfill tamping.

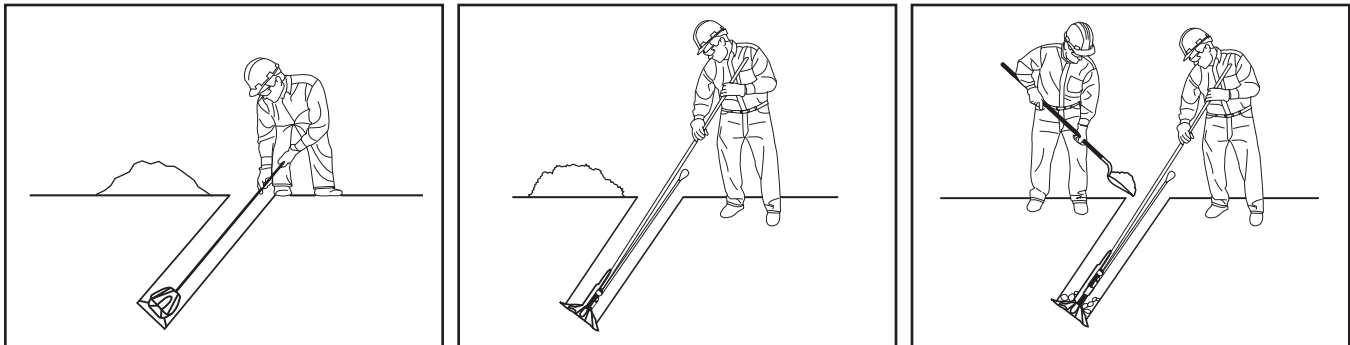

## APPLICATION AND ORDERING INFORMATION

Catalog Number	Anchor Hole Size	Area Sq. In.	Rod Size (Order Separately)	Std. Pkg./Pallet	8-Way Anchor Holding Capacity - (lbs.) vs Soil Class				
					Class 3	Class 4	Class 5	Class 6	Class 7
6870*	6"	70	5/8"	12/288	16000	14000	11000	8500	5000
88135*	8"	135	5/8" or 3/4"	6/150	26500†	22000†	18000†	15000	10000
1082	10"	200	1"	2/48	31000	26500	21000	16500	12000
108234	10"	200	3/4"	2/48	31000†	26500†	21000	16500	12000
1283	12"	300	1 1/4"	2/36	40000	34000	26500	21500	16000
12831	12"	300	1"	2/36	40000†	34000	26500	21500	16000

†Ultimate strength of rod may limit holding capacity. (See page 4-17 for rod ratings and selection.) Add suffix "G" for galvanized. Example: 88135G.

\*RUS Accepted.

Note: Capacity ratings apply to properly installed anchors only.

Failure to install within 5° of alignment with the guy load will significantly lower strength.

## EXPANDING & TAMPING BAR

The improved Chance fiberglass handle Expanding and Tamping Bar simplifies the job of expanding anchors. The curved Tamper and Expander Head distributes the weight of the bar evenly around the anchor rod to reduce handle vibration. The hook of the Expanding and Tamping Bar wraps around the anchor rod to keep the Expanding Head from slipping off the anchor top plate. This tool is also effectively used for tamping in soil above the installed anchor. The base casting is attached directly to the Epoxiglas® handle.

Cat. No.	Description	Length	Weight
C3020003	Expanding & Tamping Bar	10'	22 lbs.
C3020004	Expanding & Tamping Bar	12'	24 lbs.

To order fiberglass replacement handles or expander head, see page 4A-11.



# Cross-Plate Anchor

The Cross-Plate anchor is made for installation in holes drilled by power diggers. Because the size of the hole does not affect holding capacity, the hole can be dug by the same auger that is used to dig the pole holes on transmission projects.

Cross-Plate anchors are installed in a diagonal bored hole which is undercut so the anchor is at right angles to the guy. A rod trench is either cut with a trenching tool or drilled with a small power auger. Both anchor and rod trench should be refilled and tamped.

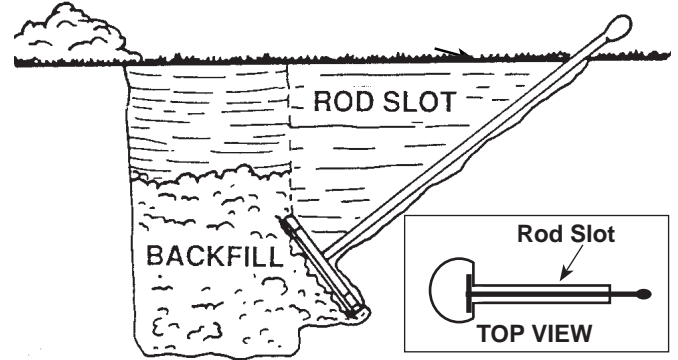

APPLICATION AND ORDERING INFORMATION						Holding Capacity <sup>‡</sup> - (lbs.) (No Safety Factors Included) vs Soil Class				
Catalog Number	Hole Size	Std. Pkg./Pallet	Approx. Wt. per Carton <sup>†</sup>	Area Sq. In.	Rod Size (order separately)	Class 3	Class 4	Class 5	Class 6	Class 7
						X16	16"	6/162	62 lb.	150
X20	20"	4/64	64 lb.	250	5/8", 3/4"	34000 <sup>‡</sup>	29000 <sup>‡</sup>	24000 <sup>‡</sup>	19000 <sup>‡</sup>	14000
X201	20"	4/64	64 lb.	250	1"	34000	29000	24000	19000	14000
X2434*	24"	1/48	34 lb.	400	5/8", 3/4"	45000 <sup>‡</sup>	37000 <sup>‡</sup>	30000 <sup>‡</sup>	23500 <sup>‡</sup>	18000 <sup>‡</sup>
X24 <sup>†</sup>	24"	1/48	34 lb.	400	1"	45000 <sup>‡</sup>	37000 <sup>‡</sup>	30000	23500	18000
X241 <sup>†</sup>	24"	1/48	34 lb.	400	1 1/4"	45000	37000	30000	23500	18000

<sup>†</sup>X24 Series are not available in carton and are shipped as individual pieces.

<sup>‡</sup>Ultimate strength of rod may limit holding capacity. (See page 4-17 for rod ratings and selection.)

Add suffix "G" for galvanized. Example: X20G.

\*RUS Accepted.

Note: Capacity ratings apply to properly installed anchors only.

Failure to install within 5° of alignment with the guy load will significantly lower strength.

## Rods, Anchor, Galvanized

### • Extensions

These anchor rod extensions primarily are for making above-grade connections between installed anchors and guy wires.



Welded Clevis style

Catalog No.	Description	Rod Dia. & Length	Clevis Bolt diameter	Std. Pkg. /Pallet	Strength, lb.
PSC1022176	TRIPLEYE®	3/4" x 24"	3/4"	5/50	23,000
PSC1022177	TRIPLEYE®	3/4" x 36"	3/4"	1/50	23,000
PSC1022178	TRIPLEYE®	3/4" x 72"	3/4"	1/50	23,000
PSC1022183	TWINEYE®	1" x 24"	7/8"	5/50	36,000
PSC1022305	TRIPLEYE®	1" x 24"	7/8"	1/50	36,000
PSC1022184	TWINEYE®	1" x 36"	7/8"	1/50	36,000
PSC1022306	TRIPLEYE®	1" x 36"	7/8"	1/50	36,000
PSC1022185	TWINEYE®	1" x 72"	7/8"	1/50	36,000
PSC1022307	TRIPLEYE®	1" x 72"	7/8"	1/50	36,000

Each extension's forged eye is designed to distribute pulling stresses uniformly over individual strands of guy wire and keep the guy wire from spreading, kinking, or bending.

The drop-forged eye of each extension rod is stronger than the rod itself. Rod length and diameter are stamped below each rod eye.

Each extension rod is hot dip galvanized and includes a high-strength bolt and nut.

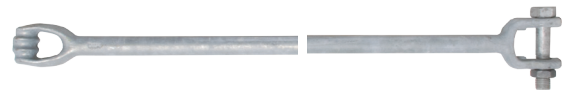

Forged Clevis style

Catalog No.	Description	Rod Dia. & Length	Clevis Bolt diameter	Std. Pkg. /Pallet	Strength, lb.
4022	TRIPLEYE®	1 1/4" x 24"	1"	1/50	40,000
PS4023	TRIPLEYE®	1 1/4" x 36"	1"	1/50	40,000
402	TRIPLEYE®	1 1/4" x 72"	1"	1/50	40,000

# Rods, Anchor, Galvanized

Available for one, two, or three guys for use with expanding and cross-plate anchors. THIMBLEYE®, TWINEYE® and TRIPLEYE® rods distribute pulling stresses uniformly over individual strands of guy wire and keep the guy wire from spreading, kinking, or bending. The drop-forged eye of each anchor

rod is stronger than the rod itself. Rod length and diameter are stamped below each rod eye. Each rod is threaded 3/16" minimum length. Nuts included.

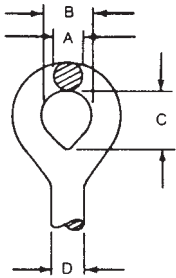

**OVALEYE ADAPTER**

D	A	B	C
5/8"	9/16"	1 1/2"	2"
1"	7/8"	1 1/2"	2"

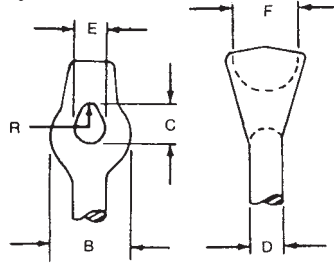

**THIMBLEYE® ADAPTER**

D	*R	B	C	E	F
1/2"	3/16"	1 1/4"	9/16"	1/2"	1 1/4"
5/8"	1/4"	1 1/2"	11/16"	9/16"	1 3/8"
3/4"	9/32"	1 5/8"	13/16"	11/16"	1 1/2"
1"	13/32"	2 1/16"	1 1/8"	15/16"	1 5/8"

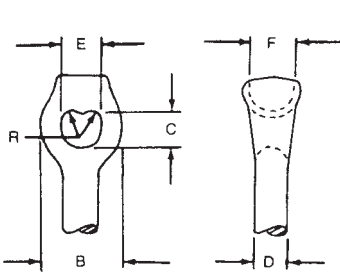

**TWINEYE® ADAPTER**

D	*R	B	C	E	F
5/8"	7/32"	1 3/4"	7/8"	15/16"	1 1/4"
3/4"	1/4"	2"	1"	1 1/16"	1 3/8"
1"	5/16"	2 5/8"	1 3/16"	1 5/16"	1 1/2"
1 1/4"	3/8"	2 15/16"	1 1/4"	1 9/16"	1 5/8"

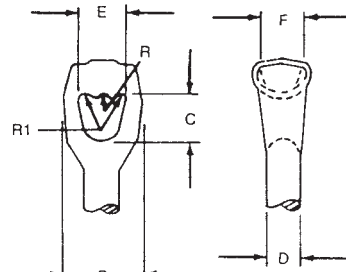

**TRIPLEYE® ADAPTER**

D	*R	*R1	B	C	E	F
3/4"	1/4"	7/32"	2 1/2"	1 11/16"	1 1/2"	1 1/4"
1"	1/4"	7/32"	2 9/16"	1 11/16"	1 5/8"	1 1/2"
1 1/4"	9/32"	1/4"	2 7/8"	1 11/16"	1 11/16"	1 5/8"



**TENSILE STRENGTH\*\***

Rod Size, in.	Strength, lb.	Nut Part No.
1/2"	10,000	55058P
5/8"	16,000	55006P
3/4"	23,000	55312P
1"	36,000	55320P
1 1/4"	58,000	56001P

\*(2 x R or 2 x R1) = maximum-diameter guy strand.

Catalog No.				Size	+Protected Rods - Catalog No.		
THIMBLEYE® Adapter	TWINEYE® Adapter	TRIPLEYE® Adapter	Ovaleye Adapter		THIMBLEYE® Adapter	TWINEYE® Adapter	TRIPLEYE® Adapter
5305	—	—	—	1/2 x 5'	—	—	—
5306	—	—	—	1/2 x 6'	—	—	—
5307	—	—	—	1/2 x 7'	—	—	—
5315	—	—	—	5/8" x 5'	—	—	—
†*5316	5346	—	—	5/8" x 6'	—	—	—
†*5317	†*5347	—	PS6417	5/8" x 7'	—	—	—
†*5318	†*5348	—	—	5/8" x 8'	—	—	—
*5326	*5356	—	—	3/4" x 6'	C2000088	C2000092	—
*5327	*5357	*7557	—	3/4" x 7'	C2000089	C2000093	C2000099
†*5328	†*5358	7558	—	3/4" x 8'	C2000090	C2000094	C2000098
—	†*5359	7559	—	3/4" x 9'	—	C2000095	C2000097
—	†5360	—	—	3/4" x 10'	C2000091	C2000096	—
*5338	*5368	7568	—	1" x 8'	C2000102	—	C2000105
—	†5369	—	—	1" x 9'	—	C2000100	—
†*5340	†*5370	7570	6440	1" x 10'	C2000103	C2000101	C2000104
—	—	C2000028	—	1 1/4 x 8'	—	—	—
—	15129	7574	—	1 1/4 x 10'	—	—	—

\*IEEE Standard †RUS Accepted.

+Galvanized rod and square nuts meet IEEE specification plus have polyethylene tube. No asphalt paint is added, so tube can slide down after anchor is expanded.

\*\*Ultimate strength ratings apply to properly installed anchors only. Failure to install within 5° of alignment with the guy load will significantly lower strength.



# EXPANDING ROCK ANCHORS

## • Saves Time, Labor, Money

The Chance Expanding Rock Anchor is a big time, labor, and money saver . . . because, in most cases, there is no need to mix concrete, melt lead, or carry extra, bulky equipment to the job. Generally, the cost of installing the Expanding Rock Anchor is about 35% less than the old-fashioned grouting method

## • Expands and Wedges

This anchor expands and wedges against solid walls of rock. And, once it is expanded, the harder the pull on the rod—the tighter it wedges. Wedges are made of malleable or ductile iron with a rust-resistant coating. Rod should be in line with the guy.

## • Installation

Installation is quick and simple. Bore the hole with hand or power drill, making sure that the diameter of the hole is 1/4-inch larger than the diameter of the unexpanded anchor. Drop the anchor in the hole. Put a bar through the large eye of the anchor rod. Turn the rod until the anchor is firmly expanded against the sides of the hole. Grouting should be done if protection of the rock against weathering is a concern.

This wedging force holds the anchor securely in place—to stay.

## • 1, 2 or 3 Guy Strands

The large drop-forged TRIPLEYE® rod of high-test steel holds up to three guy strands. The contour of the eye grooves keeps the guy strands from spreading, kinking, bending. . . and allows slack to be pulled up without binding, damaging, or weakening the guy.

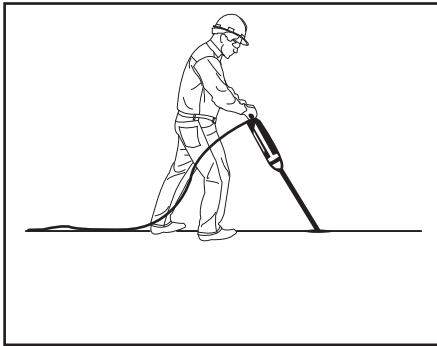

Drill hole . . .

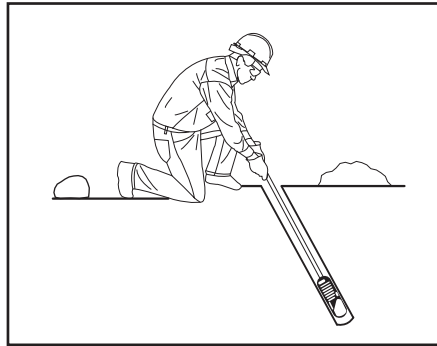

. . . push anchor into hole

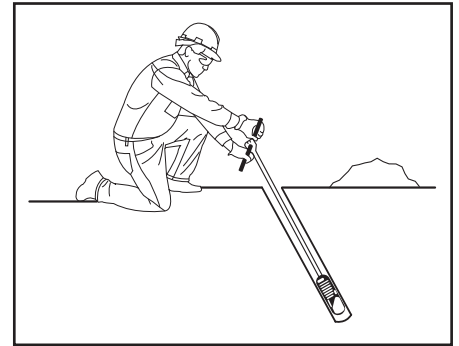

. . . turn rod to expand.

Cat. No.	Rod Dia.	Rod Lth.	Anchor Size	Anchor Fully Exp'd	Hole Size	Approx Weight Per 100	No. in. Bdl.
R315*	3/4"	15"	1 3/4"	2 3/8"	2"	500	5
R330*	3/4"	30"	1 3/4"	2 3/8"	2"	700	5
R353*	3/4"	53"	1 3/4"	2 3/8"	2"	960	5
R360	3/4"	60"	1 3/4"	2 3/8"	2"	1040	5
R372	3/4"	72"	1 3/4"	2 3/8"	2"	1200	4
R384	3/4"	84"	1 3/4"	2 3/8"	2"	1300	4
R396	3/4"	96"	1 3/4"	2 3/8"	2"	1460	3

Cat. No.	Rod Dia.	Rod Lth.	Anchor Size	Anchor Fully Exp'd	Hole Size	Approx Weight Per 100	No. in. Bdl.
R130L	1"	30"	2 1/4"	3 1/8"	2 1/2"	1166	3
R153L	1"	53"	2 1/4"	3 1/8"	2 1/2"	1833	3
R172L	1"	72"	2 1/4"	3 1/8"	2 1/2"	2133	2
R196L	1"	96"	2 1/4"	3 1/8"	2 1/2"	2666	2

\*RUS Accepted.

3/4" Rod Minimum Ultimate Strength of 23,000 pounds.

1" Rod Minimum Ultimate Strength of 36,000 pounds.

Ultimate strength ratings apply to properly installed anchors only.

Failure to install within 5° of alignment with the guy load will significantly lower strength.

Recommended minimum installation depth is 12" in solid rock.

Rods and Wedges are hot dip galvanized.

# EXTENDABLE ROCK ANCHOR

The Chance Extendable Rock Anchor uses standard PISA® couplings and rods to install the rock anchor at depths greater than standard expandable rock anchors (96"). For rods, couplings and eyenuts, see page 4-10. Hot dip galvanized.



Catalog No.	Rod Dia.	Rod Length	Std. Pkg/Pallet
R84LE	1"	84"	2/50

# GROUTED ROCK ANCHORS

The Chance Grouted Rock Anchor is designed to be used in situations where the soil is too rocky to use screw anchors, but the rock is fractured preventing the use of wedge style rock anchors. The forged knob on the end of the anchor along with any extension couplings provides the interference fit with the grout. The holding capacity of the anchor is dependent on the bond stress between the rock and the grout. The Grouted Rock anchor is designed to be used inline with the guy. Failure to install within 5° of alignment with the guy load will significantly lower strength.

To install a Grouted Rock Anchor requires first drilling a 6"-diameter hole. Then insert the anchor, assembled with any Round Rod Extensions and Guy Adapter needed. Portland-cement grout pumped in to completely fill the hole around the anchor takes approximately five days to cure.

For Application Information, see next page.

## ORDERING INFORMATION

Galvanized per ASTM A-153

### Grouted Rock Anchor — 1.25"-diameter rod

Catalog No.	Length A	Approx. Ship Wt. Each	Std Pkg/ Pallet
W1040004	36"	17.6 lb.	1/40
W1040055	84"	38.0 lb.	1/30

### RR (Round Rod) Extension — 1.25"-diameter rod

Catalog No.	Length A	Approx. Ship Wt. Each	Std Pkg/ Pallet
12696	42"	17.6 lb.	1/50
12697	60"	38.0 lb.	1/50
12698	84"	24.0 lb.	1/30
12699	120"	46.8 lb.	1/50

Note: SS5 and SS150 extensions can be used in place of the RR extensions listed above.

Typical Assembly of Components as Installed, at right

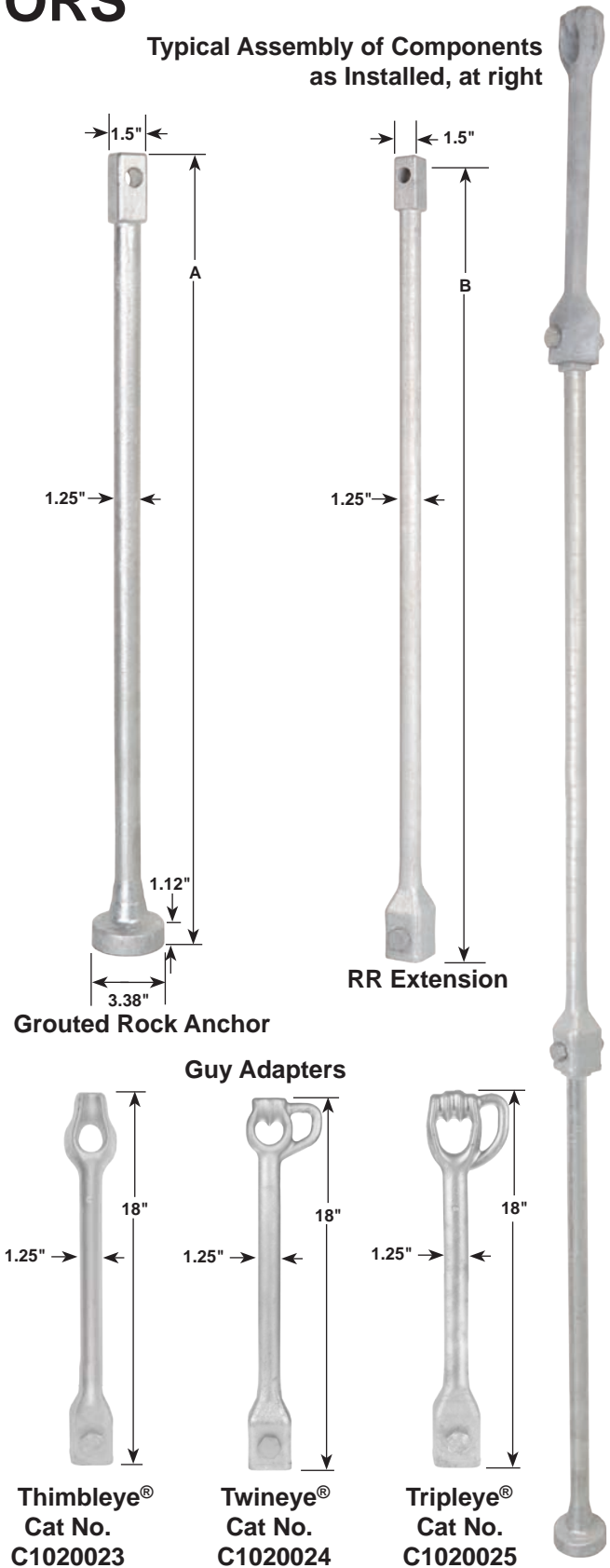



# GROUTED ROCK ANCHORS

## Application Table for Cat. No. W1040004 and W1040055

Ultimate Bond Stress  
between Rock & Grout  
psi (see Notes 1, 2, 3)

Allowable Load Capacity  
for 6" dia x 1' long grout column  
lb/ft of length (see Note 4)

Granite Basalt Dolomitic Limestone	200	15000
Soft Limestone Slates & Hard Shales Sandstone	100	7500
Soft Shales	30	1800
Soil (see Note 18) Class 5	8	600

**NOTES:**

- 1 Ultimate bond stress values from the PTI (Post Tensioning Institute) and the grout to ground bond values from the FHWA (Federal Highway Administration) were used to arrive at the indicated ultimate bond stress between rock and grout used in the above chart.
- 2 Identification of the rock and application of the chart values is the responsibility of those designing the rock anchor.
- 3 The values in the chart are intended to provide conservative results.
- 4 Higher bond stress values may be obtainable, but the associated investigation to determine appropriate values and the use of those values is left to those designing the rock anchor.
- 5 The given ultimate stresses were applied over the surface of a 6" diameter x 1' long grout column, then divided by 3 to obtain the recommended allowed load per foot of length in the indicated rock or soil.
- 6 Actual capacities will depend on the strength of the rock, the grout strength and the quality of the installation.
- 7 A rough surface in the drilled hole is preferred as well as a clean hole free of loose material, soil, dust, etc.
- 8 A 6" diameter hole is recommended for the use of the W1040004 and W1040055 rock anchors.
- 9 The minimum bond length of the rock anchor to be engaging the rock is 5 feet.
- 10 It is recommended that field testing be accomplished to confirm capacities.
- 11 Anchor grout is to be made using Type I, II, III, or V Portland Cement conforming to ASTM C-150 specifications.
- 12 The compressive strength of the grout shall be 3000 psi at the time of stressing.
- 13 The grout should be flowable to reach the bottom of the drilled hole or pumpable if it is to be placed via a grout pump.
- 14 The ultimate mechanical strength of the W1040004 and W1040055 rock anchors and associated extensions and terminations is 70,000 lbs when Chance/Hubbell anchor components are used.
- 15 Water used in the grout mix should be potable (suitable for public consumption), clean and free of substances known to be harmful to portland cement or steel.
- 16 It is recommended that grout be placed in the hole prior to inserting the rock anchor.
- 17 When using pre-packaged grout mixes follow directions and use the water cement ratio recommended by manufacturer.
- 18 For recommendations concerning bonded lengths and unbonded lengths, reference the PTI specifications.
- 19 The rock anchor is to be installed in line with the guywire. Any misalignment is to be no more than  $\pm 5$  degrees.

B

# Expanding Pole Key Anchor



**CLOSED**

## • Quicker Installing, More Efficient Than Wood Key

Made of structural steel, the Chance Pole Key anchor is used where guys are impractical or as backup to guys.

The Pole Key anchor can be installed in about 15 minutes, while it takes about 3 hours to install an old-type wood key.

The Pole Key anchor is extensively used for keying power and telephone-line poles, and wood poles used in street lighting. It is also used as a pole reinforcement in soft soils where the load is unbalanced, due to small angles or crossarm configuration.



**EXPANDED**

## Application and Ordering Information

Catalog Number	Width Expanded	Blade Width	Area Expanded	Approx. Weight	Ultimate Resisting Force at 5 ft. Depth (lb.) <sup>€</sup>			
					Soil Class 3	Soil Class 4	Soil Class 5	Soil Class 6
*P4817	27¼"	7"	276 sq. in.	24½ lb.	11,000	9,500	7,400	5,800

<sup>€</sup>The lateral load and overturning moment which can be resisted depends on the height of the load above ground level, the depths of the two opposing Pole Keys, and the allowable lateral deflection of the pole at ground line.

\*RUS Accepted. Accommodates any ¾"-diameter rod on page 4-17.

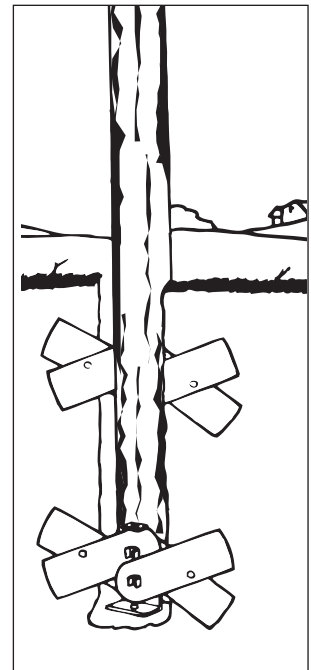
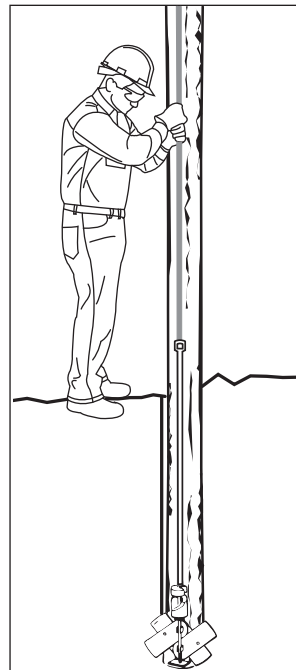
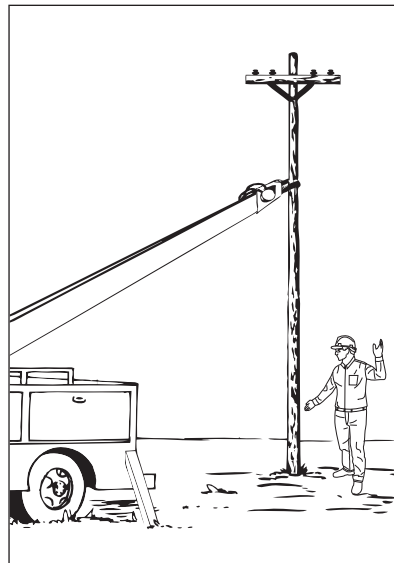
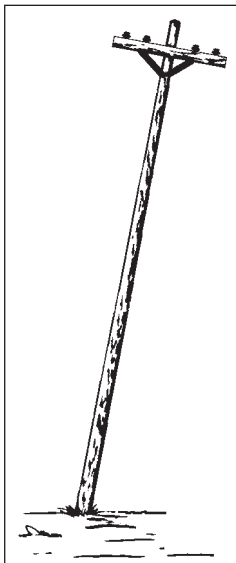

Chance Pole Key anchor is quickly installed next to a pole butt to help hold it in place against light overturning loads due to service drops, prevailing winds or small changes in line direction (See illustrations).

# Corrosion-Resistant Anchor

Chance design offers many advantages

The Chance corrosion-resistant disc anchor is designed for low resistivity, alkaline and acidic soils with electrolyte combinations. The anchor eye is forged directly to the rod, so the eye is an integral part of the anchor. The anchor's flanged cap nut is cast. It's large and heavy for greater protection. The heat-shrink sleeve over the galvanized anchor rod helps prevent moisture from going down the rod. The insulating washer is fiberglass-reinforced thermoset material for better load-bearing properties compared to thermoform materials.



**Corrosion-Resistant Anchor**

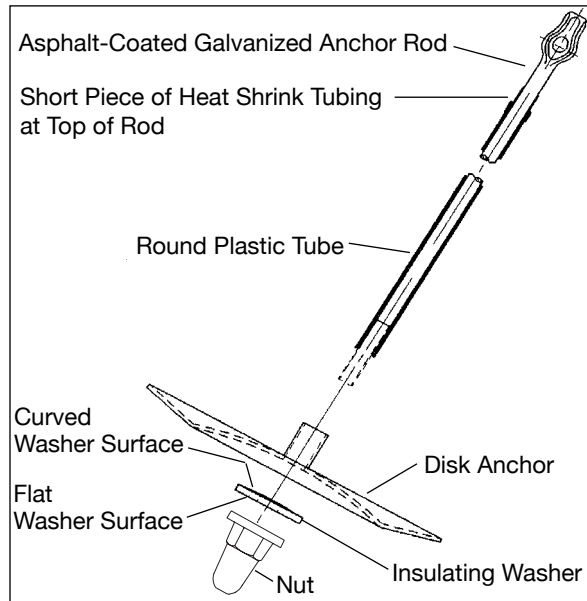

**Fiber-Reinforced Washer**

Catalog No.	Fits Rod Size	Approx. Wt./100 pcs.
C2100033	3/4"	23 lb.
C2100034	1"	19 lb.

**Holding Capacity<sup>‡</sup> - (lbs.)  
(No Safety Factors Included)  
vs Soil Class**

Catalog No.	Description	Hole Size	Fits Protected Rod Size	Holding Capacity <sup>‡</sup> - (lbs.) vs Soil Class				
				Class 3 500-600 in-lb	Class 4 400-500 in-lb	Class 5 300-400 in-lb	Class 6 200-300 in-lb	Class 7 100-200 in-lb
C1022008	16" Anchor .187" Thick	16"	3/4"	31000 <sup>‡</sup>	26500 <sup>‡</sup>	21000	16500	12000
C1022009	16" Anchor .187" Thick	16"	1"	31000 <sup>‡</sup>	26500	21000	16500	12000
C1022011	20" Anchor .187" Thick	20"	1"	40000 <sup>‡</sup>	34000	26000	21500	16000
C1022012	20" Anchor .250" Thick	20"	1"	40000 <sup>‡</sup>	34000	26000	21500	16000
C1022054	24" Anchor .187" Thick	24"	1"	50000 <sup>‡</sup>	41000 <sup>‡</sup>	33500	26000	20000
C1022050	24" Anchor .250" Thick	24"	1"	50000 <sup>‡</sup>	41000 <sup>‡</sup>	33500	26000	20000



**Cap Nut**

Catalog Number	Fits Rod Size	Approx. Wt./100 pcs.
C2050407	3/4"	242 lb.
C2050408	1"	242 lb.

<sup>‡</sup>Ultimate strength of rod may limit holding capacity.

Note: Capacity ratings apply to properly installed anchors only.

Failure to install within 5° of alignment with the guy load will significantly lower strength.

## Protected Rod for Corrosion-Resistant Anchor

These rods include fiber-reinforced washer and heavy-forged cap nut. Nut is attached to rod. Washer is shipped separately in a box. Galvanized Rod meets NEMA specification PH2 plus has asphalt coating, polyethylene tube and heat shrink collar.

Rod Size	Rod Tensile Strength, lb.	Thimbleye® Adapter		Twineye® Adapter		Tripleye® Adapter	
		Catalog No.	Lb./100 Pcs.	Catalog No.	Lb./100 Pcs.	Catalog No.	Lb./100 Pcs.
3/4" x 6'	23,000	C2000047	1330	C2000053	1362	C2000106	—
3/4" x 7'	23,000	C2000048	1450	C2000054	1470	—	1630
3/4" x 8'	23,000	C2000049	1566	C2000055	1650	C2000061	1783
3/4" x 9'	23,000	—	—	C2000056	1750	C2000062	1883
3/4" x 10'	23,000	C2000050	1826	C2000057	1910	—	—
1" x 6'	36,000	—	—	—	—	C2000107	—
1" x 7'	36,000	—	—	C2000114	—	—	—
1" x 8'	36,000	C2000051	2500	C2000108	—	C2000063	2730
1" x 9'	36,000	—	—	C2000058	2800	—	—
1" x 10'	36,000	C2000052	3005	C2000059	3050	C2000064	3270

For additional sizes of rods, contact Hubbell Power Systems, Inc.



# Bumper Posts

## for instant equipment protection

### • Power-Installed Design



Protect transformers, switchgear and guys. Any equipment needing bumper protection is an ideal candidate. Cheaper than concrete. Installation in minutes regardless of weather conditions. Available power diggers can install through black-top surfaces. Hot-dip galvanized corrosion-resistant finish.

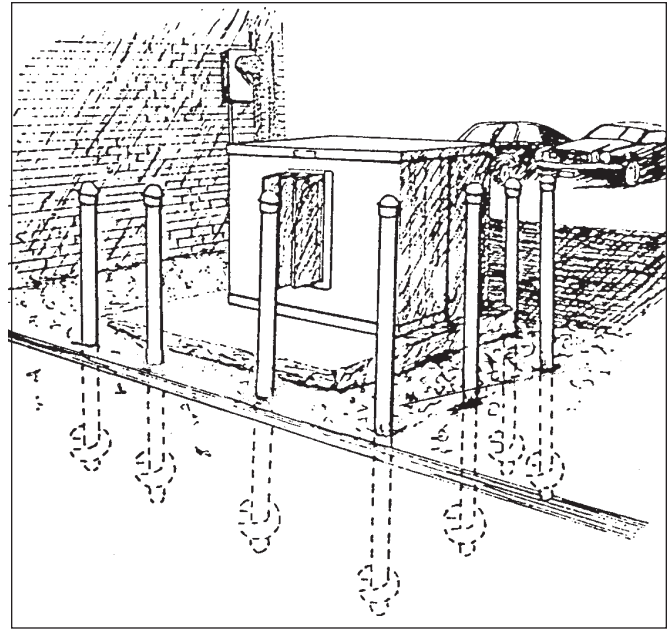

B

### ORDERING INFORMATION

8,000 ft.-lb. Typical Working Torque

Catalog Number	Std. Pkg./Pallet	Weight ea., lb.	Description
T1120192	1/12	45	8" Helix, 3 1/2" O.D. x 60" Shaft
T1120224	1/12	53	8" Helix, 3 1/2" O.D. x 75" Shaft
C1120275	1/12	61	8" Helix, 3 1/2" O.D. x 84" Shaft

### Installing Tools

Additional tools may not be required for Bumper Post if Kelly bar can be inserted into the 3.06" inside dia. of the post and pinned by a bent-arm pin.

Tools are available which bolt directly to Chance Kelly bar adapters or which can be used with Chance locking dog assembly.

Order C3030737 for Kelly bar attachment or C3030739 for use with locking dog assembly. Bumper Post is inserted into drive tool and held by the provided bent-arm pin.



C3030739

C3030737



# CHANCE®

## POLE BEARING PLATES

Not sold in pairs, each pole bearing plate is made of  $\frac{3}{8}$ "-thick steel plate per ASTM A36 and hot-dip galvanized per ASTM A153.

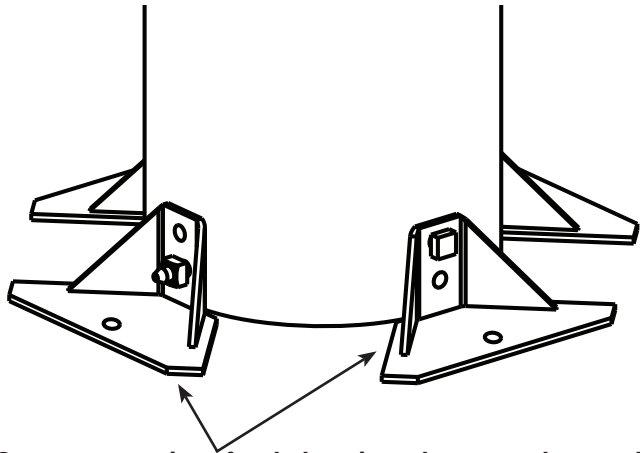

One or two pairs of pole bearing plates can be used. Note how each pair mounts with one bolt through upper or lower locating hole.



Bolts and lag screws are not included. Order separately from Catalog Section 5.

**POLE BEARING PLATE**  
Catalog No. C1100926  
Sold as a single unit, not in pairs.

One pair of these plates adds 180 square inches of bearing area to that of a pole bottom. Two pairs add 360 square inches.

### LARGE POLE BEARING PLATE

One pair of these plates adds 245 square inches of bearing area to that of a pole bottom. Two pairs add 490 square inches.

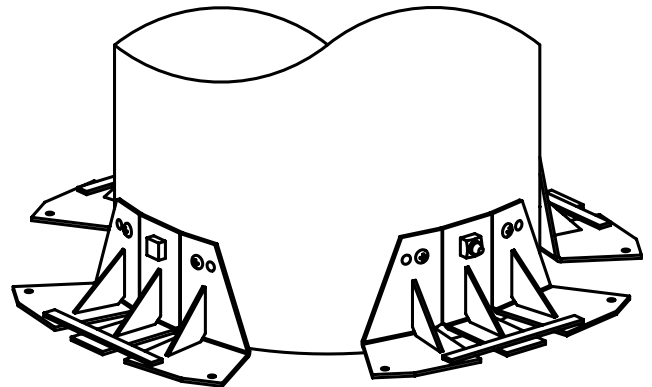
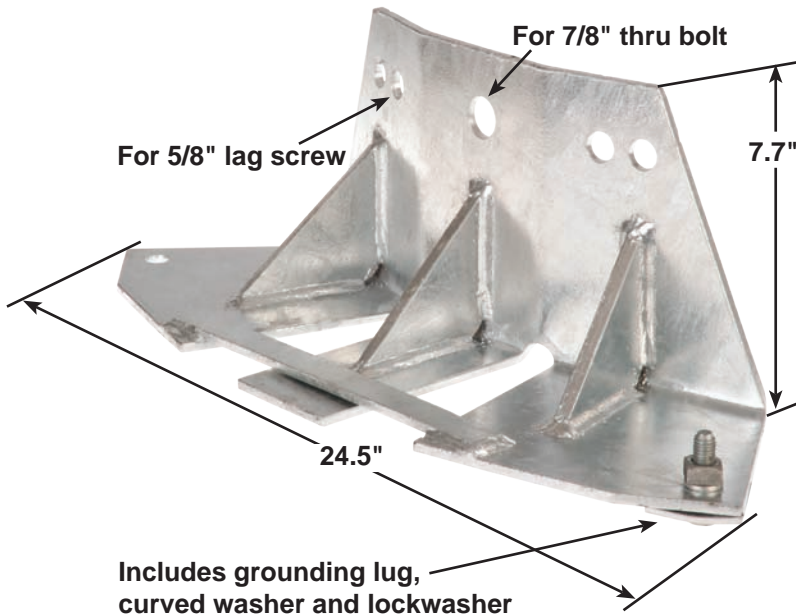

One or two pairs of pole bearing plates can be used.

Plate only Catalog No. C1100954

Kits also are available.

To order multiple units and/or include  $\frac{7}{8}$ " bolts and/or  $\frac{5}{8}$ " lag screws, select suffixes and add to the basic Catalog No. as shown below.

C1100954 2 16 H

- H = Two  $\frac{5}{8}$ " x  $4\frac{1}{2}$ " lag screws per plate
- One  $\frac{7}{8}$ " bolt per plate (specify length in inches: 16, 18, 20, 22, 24, 26, 28 or 30)
- Plates quantity (specify only 2 or 4)

# Helical Pole Support

Chance Helical Pole Supports are used with SS5 or SS150 Square Shaft anchors to help prevent a direct buried pole from sinking in soft soils. Support installs in the bottom of the pole hole.

Hot-dip galvanized per ASTM A153.

- Saves time and money.
- Installs in minutes with Standard PISA® or TOUGH ONE® anchor drive tools.
- Auger standard size pole hole – unlike oversize hole for pole bearing plates.
- Less spoils to remove.
- Greener method than expanding foam!

Bearing capacity can be estimated using soil class or calculated by measuring torque. The bearing capacity is shown below for SS5 and SS150 anchors (40,000 lb. maximum). For example a 100-foot Douglas fir pole weighs approximately 10,000 lb., which can be supported in a class 7 soil by an SS5 Lead Section with 8" and 10" helix plates.

SS5/SS150 Lead Section		Bearing Capacity (lb.) vs Soil Class					
Length	Helix Combinations	Class 7	Class 6	Class 5	Class 4	Class 3	Class 2
3 ft.	8" - 10"	19,000	23,000	27,000	32,000	36,000	*40,000
3½ ft.	10" - 12"	21,000	26,000	31,000	36,000	*40,000	*40,000
5½ ft.	8" - 10" - 12"	26,000	32,000	39,000	*40,000	*40,000	*40,000
7 ft.	10" - 12" - 14"	29,000	37,000	*40,000	*40,000	*40,000	*40,000
10½ ft.	8" - 10" - 12" - 14"	31,000	40,000	*40,000	*40,000	*40,000	N/A
10½ ft.	10" - 12" - 14" - 14"	40,000	*40,000	*40,000	*40,000	N/A	N/A

Notes: Holding capacities are based on average test data and are offered as an application guide only.  
\* 40,000 lb. maximum load

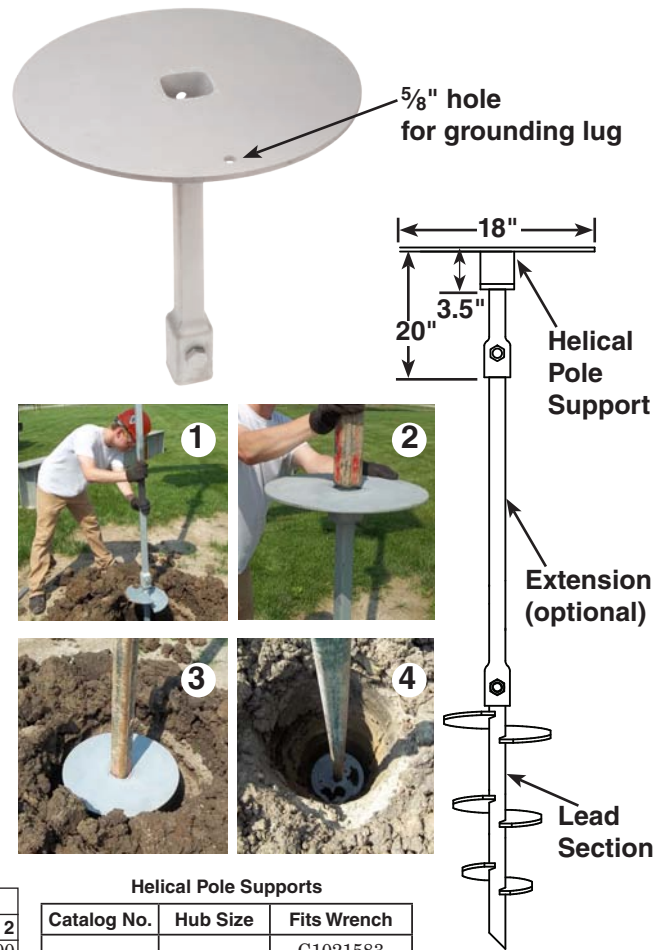

Helical Pole Supports		
Catalog No.	Hub Size	Fits Wrench
C1100941	2.25"	C1021583
		C1022595
C1100929	2.5"	C3031064
		C3031063
		C3030983
		C3030982

# Pole Clip

Provides an adjustable method of attachment from a pole near the groundline to an appropriate PISA® helical anchor. Hot-dip galvanized per ASTM A153.

Used primarily on H-frame structures, the anchors are installed as close as possible to the pole at the ground line. The installation helps prevent jacking or "walking" the structure out of the ground.

The stud bolt is mounted to the exposed end of the PISA rod and attached to the Pole Clip which is bolted to the pole. 5½" of threads on the stud bolt provide adjustability. The anchors are installed using the same drive tools as when installing PISA anchors for guying applications.

### Ordering Information

Catalog No.	Standard Pkg.	Wt. per 100 pieces, lb.	Description
E1020690	8	788	For ¾" and 1" rods



# ANCHOR TOOLING

## Table of Contents

- B-31 How to Match Chance PISA® Anchors and Installing Wrenches
- B-32 PISA® Tooling (10,000 ft-lb System)
- B-33 Building a Drive String (PISA®, RR and SS Anchors)
- B-34 TOUGH ONE® Tooling (15,000 ft-lb System)
- B-35 Bent Arm Pin and Coil Lock Information
- B-36 Adapters (Reducers, SS and No Wrench)
- B-37 Chance Torque Indicators (Digital & Shear Pin)
- B-38 Soil Test Probe Assemblies
- B-39 Expanding Bar and Pulling Eye
- B-40 Portable Anchor Installers for Small Foundations
- B-41 Portable Anchor Installers and Hydraulic Power Unit
- B-42 Anchor/Foundation Drive Heads and Mounting
- B-43 Components for Skid-Steer and Backhoes

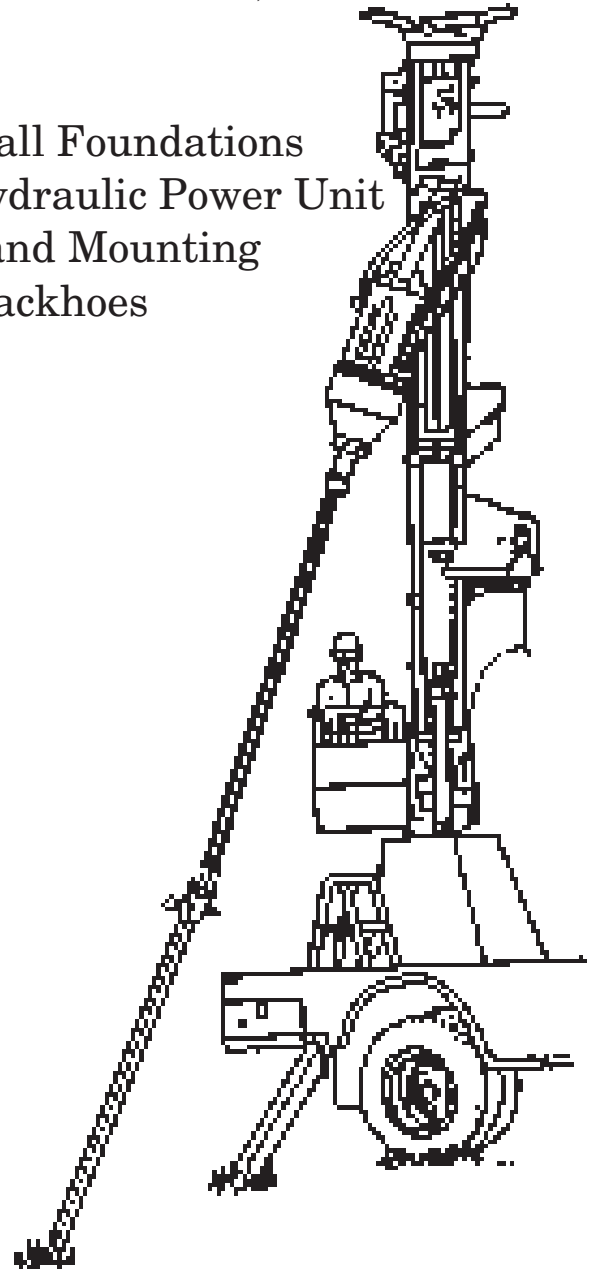

# How to Match CHANCE® Anchors and Installing Wrenches

Installing Wrench Catalog Number	Length (ft.)	Maximum Installing Torque Rating (ft-lbs)	Inside Dim. (Inches)	Outside Dim. (Inches)	Anchor Type		Torque Rating (ft-lbs)	Length (ft.)	Maximum Installing Torque Rating (ft-lbs)	Color		
					Anchor	Hub						
*C102-1583	7'	10,000	2.16	1.46				7'	10,000	2.16	1.46	Orange
*C102-1595	3½'	10,000	2.16	1.46				3½'	10,000	2.16	1.46	Yellow
*C303-1064	7'	10,000	2.44	1.54				7'	10,000	2.44	1.54	Yellow
*C303-1063	3½'	10,000	2.44	1.54				3½'	10,000	2.44	1.54	Yellow
*C303-0983	7'	15,000	2.44	1.54				7'	15,000	2.44	1.54	Red
*C303-0982	3½'	15,000	2.44	1.54				3½'	15,000	2.44	1.54	Red
<b>Maximum Installation Torque Rating (ft-lbs)</b>												
PISA® 6 Anchor (formerly PISA® 5 Anchor)												
PISA® 7 Anchor												
Standard-Strength PISA® Anchor												
Mid-Strength PISA® Anchor												
C102-52XX Series Tough ONE® Anchor - Small Hub												
C102-52XX Series Tough ONE® Anchor - Small Hub												
C102-50XX Series Tough ONE® Anchor - Large Hub												
C102-50XX Series Tough ONE® Anchor - Large Hub												

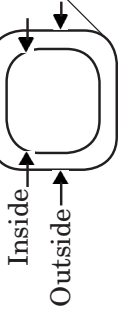

Inside and outside dimensions correspond to the color coded end of installing wrench.

NOTE: Hubbell has a policy of continuous product improvement. We reserve the right to change design and specifications without notice.

©2006 & 2011 Hubbell, Incorporated • 210 N. Allen St. • Centralia, MO 65240

Printed in USA

**Bulletin 04-9114AT**  
RGS Rev 1/14



# STANDARD and HYBRID PISA® Anchor Installing Tools

## (For installing torques up to 10,000 ft.-lb.)

A complete tool system consists of: Kelly bar adapter, torque indicator, locking dog assembly and drive-end assembly. For instructions for selecting the proper Kelly bar adapter, see page 4A-5.

### • Convertible to Extension Use

Extension assemblies can be added where soil conditions

dictate that anchors be set more than one rod length deep or where digger to ground clearances are limited.

### • Transmits Torque to Anchor Core

The wrench transmits the torque from the Kelly bar of the digger to the hub of the Power-Installed Screw Anchor so that the anchor rod need be only large enough in diameter to support the guy load.

#### STANDARD Kelly Bar Adapter with Bent Arm Pin (5 1/4" Bolt Circle)

Part No.	Kelly Bar Shape	Kelly Bar Dimension			Wt. ea., lb.
		X	Y	Z	
630013	Hex	2"	5"	6 1/8"	10
630011HD	Hex	2 1/2"	4 1/4"	8 1/8"	18
630012HD	Hex	2 5/8"	4 1/4"	8 1/8"	18
630015	Square	2 1/2"	2 3/4"	7"	13 1/4"
630017	Square	2 1/2"	2 1/2"	3 1/2"	9

Each STANDARD Kelly bar adapter has six holes for 1/2" bolts on a 5 1/4" bolt circle and comes with six 1/2" Grade 5 bolts, nuts, lock washers and bent arm pin with coil lock.

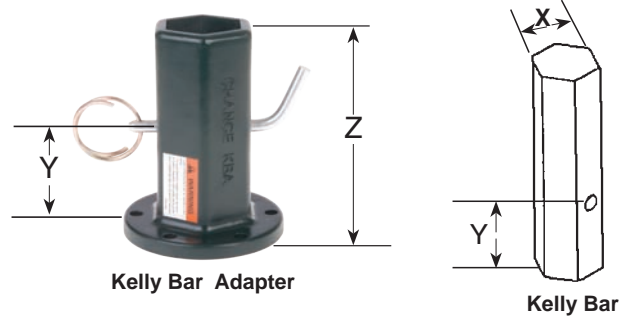

P0010259P	Hex Bolt
055371P	Lockwasher
055635P	Hex Nut

#### STANDARD Locking Dog Assembly

Cat. No.	Description	Wt.ea.
C3030069HD	Complete STANDARD Locking Dog Assembly	20 lb.
C3030070	Locking Dog Replacement Kit includes parts needed to replace both locking dogs	4 lb.
P1300007P	Replacement Ring Only	0.10 lb.

STANDARD Locking Dog Assembly has six holes for 1/2" bolts on a 5 1/4" bolt circle, comes with six 1/2" Grade 5 bolts, nuts and lock washers.

#### STANDARD Locking Dog Assembly C3030069HD

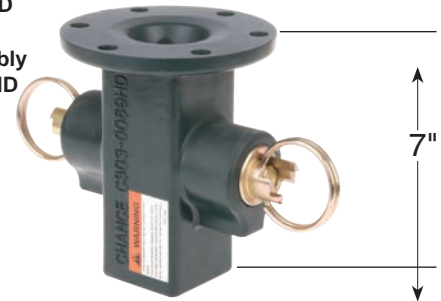

#### 7-ft. Drive-End Wrench

C1021583	STANDARD Drive-End Wrench installs 8,000 ft.-lb. (small hub) TOUGH ONE® anchors, 10,000 ft.-lb. (small hub) TOUGH ONE® anchors, 4,000 ft.-lb. Standard-Strength PISA anchors, 6,000 ft.-lb. Mid-Strength PISA anchors	57 lb.
*C3031064	HYBRID Drive-End Wrench installs 10,000 ft.-lb. (large hub) TOUGH ONE® anchors, 6,000 ft.-lb. PISA 6 anchors, 7,000 ft.-lb. PISA 7 anchors	64 lb.

#### 3 1/2-ft. Drive-End Wrench

C1021595	STANDARD Drive-End Wrench installs 8,000 ft.-lb. (small hub) TOUGH ONE® anchors, 10,000 ft.-lb. (small hub) TOUGH ONE® anchors, 4,000 ft.-lb. Standard-Strength PISA anchors, 6,000 ft.-lb. Mid-Strength PISA anchors	29 lb.
*C3031063	HYBRID Drive-End Wrench installs 10,000 ft.-lb. (large hub) TOUGH ONE® anchors, 6,000 ft.-lb. PISA 6 anchors, 7,000 ft.-lb. PISA 7 anchors	28 lb.

#### Extension Wrench

##### for above STANDARD and HYBRID Drive-End Wrenches

630027	3 1/2-ft. Extension	42 lb.
630028	7-ft. Extension	70 lb.

\*NOTE: These wrenches will fit 15,000 ft.-lb. TOUGH ONE® anchors dimensionally, but . . . MUST NOT be used for TORQUES IN EXCESS of 10,000 ft.-lb.!

\*NOTE: The old-style HYBRID wrenches C3031063 and C3031064, having a collar welded around the drive end, fit only PISA 6 and PISA 7 anchors.

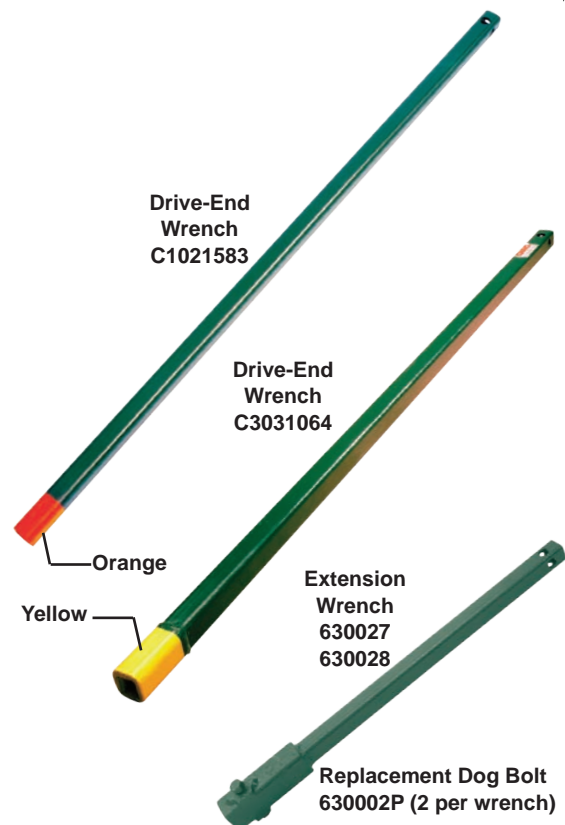

# SCREW ANCHOR DRIVE TOOL STRINGS

Selecting the correct Kelly Bar Adapter is key to building a successful Drive String. Follow these two easy steps:

- 1) Remove the auger from the digger and carefully measure the X and Y dimensions of the Kelly bar.
- 2) Match the shape of the Kelly bar and the X and Y dimensions with the Kelly bar adapter chart provided on page 4A-4 or 4A-6. The Y dimension on the Kelly bar adapter must be equal to or greater than the "Y" dimension on the Kelly bar itself.

## A Note about Bolt Circles

Chance anchor installing tools are provided with appropriate bolt circles for the expected service. The torque limitations for the three standard bolt circles are give below. **Never exceed the rated torque of any Chance installing tool.**

Bolt Circle	Use for Torque up to
(6) 1/2" Grade 5 bolts on 5 1/4" Bolt Circle	10,000 ft.-lb.
(6) 5/8" Grade 2 bolts on 7 5/8" Bolt Circle	15,000 ft.-lb.
(12) 5/8" Grade 2 bolts on 7 5/8" Bolt Circle	20,000 ft.-lb.

**Drive Strings  
for  
PISA® Anchor,  
SS Anchor  
or  
RR Anchor  
Installations:**

**Drive String  
for  
SS Anchor  
or  
RR Anchor  
Installations:**

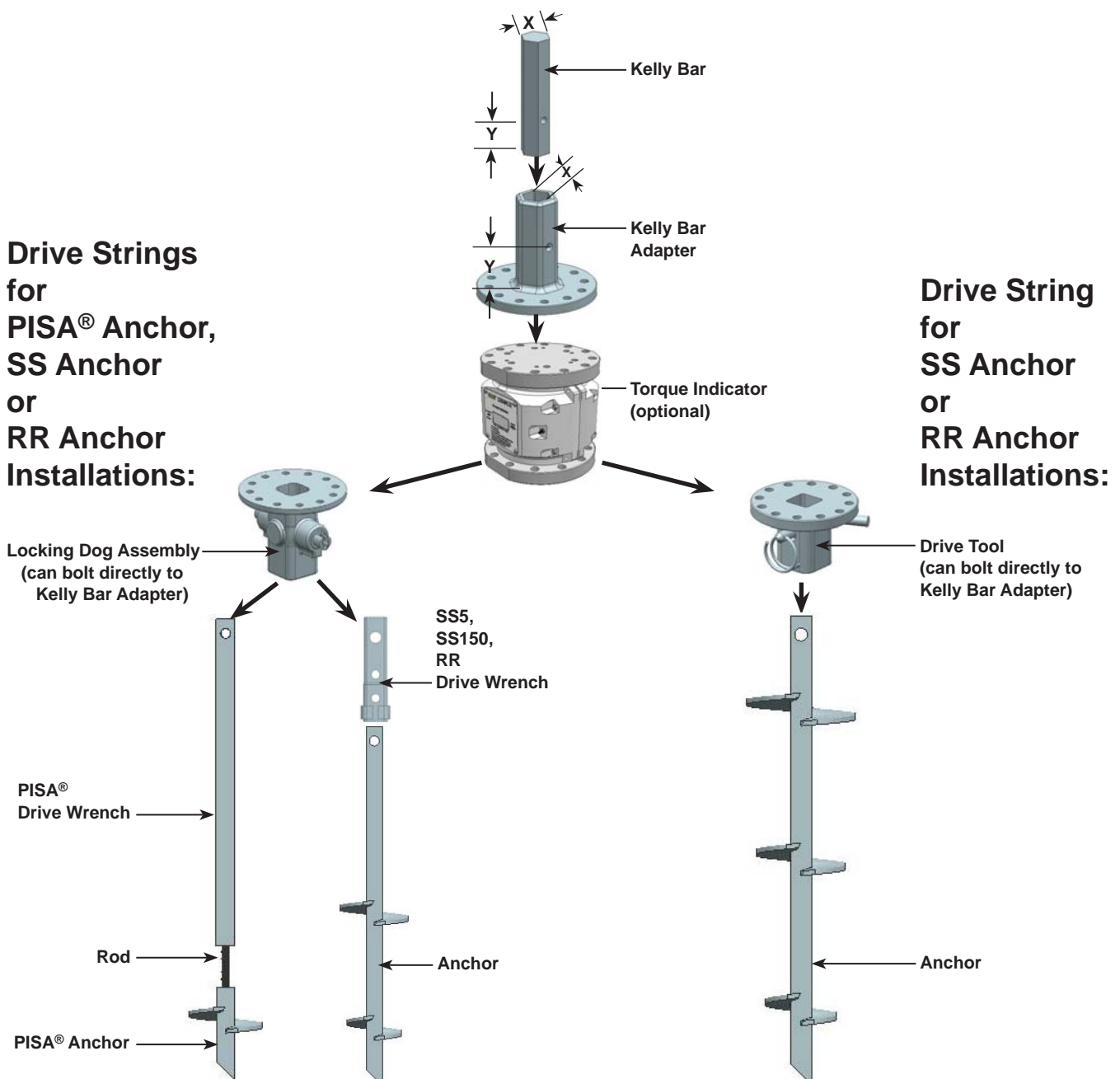

B

# TOUGH ONE® Anchor Installing Tools

## (For installing torques up to 15,000 ft.-lb.)

A complete tool system consists of: Kelly bar adapter, torque indicator, locking dog assembly and drive-end assembly. For instructions for selecting the proper Kelly bar adapter, see page 4A-5.

### TOUGH ONE Kelly Bar Adapter with Bent Arm Pin (7<sup>5</sup>/<sub>8</sub>" Bolt Circle)

Part No.	Kelly Bar Shape	Kelly Bar Dimensions			Weight, lb.	5 <sup>5</sup> / <sub>8</sub> " Gr. 2 Bolts Included	Bent Arm Pin Included
		X	Y	Z			
C3030936	Hex	2 <sup>1</sup> / <sub>2</sub> "	3 <sup>7</sup> / <sub>8</sub> "	8 <sup>1</sup> / <sub>4</sub> "	23	12	C3031223
C3030937	Hex	2 <sup>5</sup> / <sub>8</sub> "	3 <sup>7</sup> / <sub>8</sub> "	8 <sup>1</sup> / <sub>4</sub> "	23	12	C3031223
C3030940	Hex	3"	4 <sup>1</sup> / <sub>2</sub> "	8"	27	12	C3031222
C3030955	Square	2 <sup>1</sup> / <sub>2</sub> "	4 <sup>3</sup> / <sub>4</sub> "	7"	22	12	C3031227
C3030958	Square	3"	3 <sup>1</sup> / <sub>2</sub> " & 4 <sup>15</sup> / <sub>16</sub> "	7"	23	12	C3031227
C3031571	Square	3 <sup>1</sup> / <sub>2</sub> "	2' & 4"	6 <sup>11</sup> / <sub>16</sub> "	33	12	C3031227

Each TOUGH ONE® Kelly bar adapters has twelve holes for 5<sup>5</sup>/<sub>8</sub>" bolts on a 7<sup>5</sup>/<sub>8</sub>" bolt circle, comes with twelve 5<sup>5</sup>/<sub>8</sub>" Grade 2 bolts, nuts & lockwashers and bent arm pin with coil lock.

### \*Digital Torque Indicator

Catalog No.	Description	Wt., lb.
C3031578	Torque Indicator adaptable to 5 <sup>1</sup> / <sub>4</sub> " B.C. or 7 <sup>5</sup> / <sub>8</sub> " B.C.	65

\*See page 4A-9 for additional information on Chance Torque Indicators.

### TOUGH ONE Locking Dog Assembly

Catalog No.	Description	Wt., lb.
C3030981	Complete TOUGH ONE Locking Dog Assembly	28
C3031026	Locking Dog Replacement Kit Includes all parts less casting, bolts, nuts, washers	5

TOUGH ONE locking dog assembly has twelve holes for 5<sup>5</sup>/<sub>8</sub>" bolts on a 7<sup>5</sup>/<sub>8</sub>" bolt circle and comes with twelve 5<sup>5</sup>/<sub>8</sub>" Grade 2 bolts, nuts and lockwashers.

Hex Bolt	056653P
Lockwasher	055827P
Hex Nut	055803P

### TOUGH ONE Drive-End Wrenches

Catalog No.	Length	Description	Wt., lb.
C3030982	3 <sup>1</sup> / <sub>2</sub> ft.	Installs 15,000 ft.-lb. (large hub) TOUGH ONE®	36
C3030983	7 ft.	Anchors, 10,000 ft.-lb. (large hub) TOUGH ONE® and all 1 <sup>1</sup> / <sub>2</sub> " Core Anchors	73

TOUGH ONE® drive ends are painted with a red band on the bottom.

### Extension Assemblies for TOUGH ONE Drive-End Wrench

Catalog No.	Length	Description	Wt., lb.
C3030987	3 <sup>1</sup> / <sub>2</sub> ft.	Extension attaches to drive-end wrench	53
C3030988	7 ft.	when additional depth is required.	89

For SS and RR Anchor Tool options when using the TOUGH ONE® Drive String System, see page 4A-8.

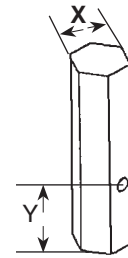

Kelly Bar

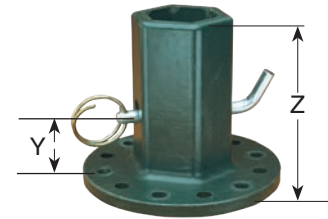

Kelly Bar Adapter

Hex Bolt	056653P
Lockwasher	055827P
Hex Nut	450314P



\*Torque Indicator

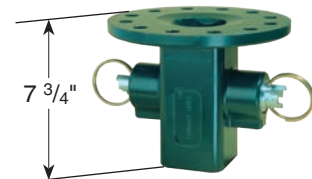

Locking Dog Assembly



Drive Wrench

Red →

# ANCHOR INSTALLING TOOL BENT ARM PIN WITH COIL LOCK

Use with STANDARD and TOUGH ONE® Kelly bar adapters, SS, RR and bumper post installing tools

Each Chance plated-steel Bent Arm pin is designed to attach a Kelly bar adapter to a Kelly bar. Also used to secure SS, RR and bumper post anchors to anchor drive tools.

Bent Arm Pins with Coil Locks are included with new tools as required. Order Pins and Coil Locks for existing tools as shown below.

## ORDERING INFORMATION

Kelly Bar Adapter	Bent Arm Pin and Coil Lock Assembly	SS/RR Tools	Bent Arm Pin and Coil Lock Assembly
*630010	C3031227	639001	C3031226
*630011	C3031223	C3030195	C3031225
630011HD	C3031223	C3030201	C3031224
*630012	C3031223	C3030202	C3031224
630012HD	C3031223	C3030020	C3031226
630013	C3031223		
630013A	C3031223		
630014	C3031222		
630015	C3031222		
630016	C3031227		
630017	C3031227		
C3030936	C3031223		
C3030937	C3031223		
C3030940	C3031222		
C3030955	C3031227		
C3030958	C3031227		
C3031571	C3031227		

Bumper Post Tools	Bent Arm Pin and Coil Lock Assembly
C3030737	C3031227
C3030739	C3031227



## ! WARNING

Chance Bent Arm Pins with Coil Locks are the only tested and approved means for through-pin attachment of drive tools. Do not attempt to use any other means of attachment.

\*Old-style Kelly Bar Adapters, no longer available.

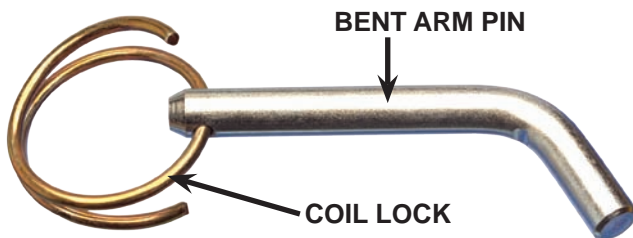

To order Coil Lock only, order Part No. P3031215P.

Bent Arm Pin and Coil Lock Assembly	Size
C3031226	3" x 5/8"
C3031225	3 1/2" x 3/4"
C3031224	4 1/2" x 1"
C3031227	5" x 3/4"
C3031223	4 1/2" x 1 1/2"
C3031222	5" x 5/8"

## ! WARNING

Always use the approved combination of Coil Locks and Bent Arm Pins. Never attempt to use any other combinations, such as hair pins, cotter keys, etc., with Bent Arm Pins.

# DRIVE TOOLS

## FOR INSTALLING SS OR RR ANCHORS

These tools include our proprietary Alignment Window that helps reduce chance of finger pinch when anchor is inserted into tool. Alignment Window also makes it faster and easier to line up the anchor and anchor tool.

These drive tools require the appropriate Kelly bar adapter, sold separately. Each comes with bolts, nuts and lockwashers.

Cat. No.	Description	Bolt Circle	Approx. Wt., lb.
639001	SS5/SS150/RR Drive Tool	(6) 1/2" holes on 5 1/4" B.C.	7
C3030195*	SS175 Drive Tool	(12) 5/8" holes on 7 5/8" B.C.	18
C3030201*	SS200 Drive Tool	(12) 5/8" holes on 7 5/8" B.C.	30
C3030202*	SS225 Drive Tool	(12) 5/8" holes on 7 5/8" B.C.	30

\*Requires use of T3030166 adapter, and limited to 10,000 ft.-lb., when used with STANDARD Kelly bar adapter (with a 5 1/4" bolt circle).

These tools slide into locking dog adapter and are retained by spring loaded dogs.

Cat. No.	Description	Unit fits:	Approx. Wt., lb.
C3030020	SS5/SS150/RR Drive Tool	STANDARD Locking Dog Assembly	8
C3031035	SS175 Drive Tool	TOUGH ONE® Locking Dog Assembly	11
T3031403	SS200 Drive Tool	TOUGH ONE® Locking Dog Assembly	26
C3031077	SS225 Drive Tool	TOUGH ONE® Locking Dog Assembly	23

Each of these drive tools includes an integral set of locking dogs that attach the drive tool to the anchor. There is no need to use bent arm pin and coil lock to attach these tools to an anchor.

These drive tools require the appropriate Kelly bar adapter, sold separately. Each comes with bolts, nuts and lockwashers.

Cat. No.	Description	Bolt Circle	Approx. Wt., lb.
C3031650	SS5/SS150 Drive Tool with Locking Dogs	(6) 1/2" holes on 5 1/4" B.C.	10
C3031645	SS175 Drive Tool with Locking Dogs	(12) 5/8" holes on 7 5/8" B.C.	21

## TOOL FOR INSTALLING NO-WRENCH ANCHORS AND MANUAL FOUNDATIONS

Especially designed for use with the Chance portable anchor installer. This tool bolts directly to the installer's output flange or Kelly bar adapter having six 1/2" dia. holes on a 5 1/4" bolt circle. Adjustable pivoting plates accept rods from 3/4" to 1 1/4" diameter.

For manually-installed foundations, eyenut must be temporarily installed for installation. Has four holes on 5 1/4" bolt circle for attachment. Includes four 1/2" x 1 1/2" bolts, nuts and lockwashers.

Cat. No.	Weight, lb.
E3030255	9



639001



C3030020



C3031650



E3030255

# CHANCE TORQUE INDICATORS

Using a Chance Torque Indicator, you can install screw anchors to a pre-determined torque value which gives a positive indication of anchor holding capacity in any type soil. These tools also help your crew avoid excessive torsional loading which could cause damage to the anchor and/or other anchor tools during installation.

The Indicators are mounted between the Kelly bar adapter and drive wrench or locking dog assembly.

## DIGITAL TORQUE INDICATOR

Catalog No. C3031578

For Installing torques up to 30,000 ft.-lb.



The LED display is easy to read in full daylight and gives the operator a direct readout of installation torque at all times.

- No Shear pins to replace.
- Operational temperature range: -40° to 80°C (-40° to 175° F).
- Accuracy: ±500 ft.-lb. at any reading.
- Torque is measured using strain gauges.
- Powered by a standard 9V battery.

Top and bottom flange, each provides:

Six holes tapped 1/2"-13 on a 5 1/4" bolt circle and Twelve holes tapped 5/8"-11 on a 7 3/8" bolt circle.

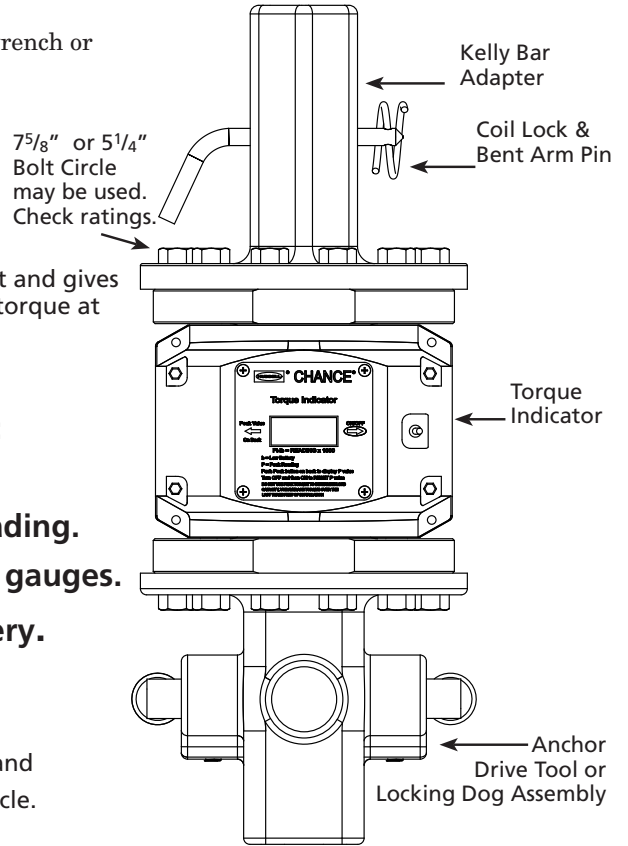

- Digital Torque Indicator is not recommended in heavy, rocky soil applications.

Catalog Number	Description	Weight, lb.
C3031578	Digital Torque Indicator <ul style="list-style-type: none"> <li>• Twelve 1/2" Grade 5 bolts and lockwashers for use on 5 1/4" Bolt Circle tools</li> <li>• Twenty-four 5/8" Grade 2 bolts and lockwashers for use on 7 3/8" Bolt Circle tools</li> <li>• Standard 9V battery</li> </ul>	65



## SHEAR PIN TORQUE LIMITER

Catalog No. C3030044

For Installing torques up to 10,000 ft.-lb.

Offers: Protection for anchors and installing tools by disconnecting the power when the installing torque reaches a preselected level.

Useable in very rocky soil.

Durable — does not require special storage or handling.

Top and bottom each has six holes tapped 1/2" - 13 on a 5 1/4" bolt circle.

Catalog Number	Description	Wt., lb.
C3030044	Shear Pin Torque Indicator	54
*C3030045	One Carton of Shear Pins (Approx. 1700 pins)	50
*T3031420	One Box of Shear Pins (Approx. 510 pins)	15

\*Each Shear Pin provides 500 ft.-lb. of torque.

# SOIL TEST PROBE



## • Determine soil conditions without taking core samples

The Chance Soil Test Probe is a mechanical instrument which enables the operator to determine the condition of the sub-soil without core samples. A ratchet-handle torque wrench which slides up and down on the shaft is used to install or retract the probe. Torque wrench readings, in inch-pounds, provide a way to measure the consistency of the sub-soil. The torque values obtained are translated into soil classifications using the copyrighted Chance Soil Classification Table (see below) located on the inside flap of the carrying case.

Torque readings are taken at the depth to which an anchor is to be installed, and at least 2 feet above this depth because the average earth consistency 2 to 3 feet above the anchor determines the anchor holding capacity. The probe shaft is marked at 1-foot intervals permitting soil evaluation at every foot of depth.

The length of the Soil Test Probe (including helix) is 5 feet. Each shaft coupled to the probe provides an additional 5 feet. A durable carrying case protects the equipment when not in use.

## ORDERING INFORMATION

### Soil Test Probe 1800 in.-lb. Capacity

Cat. No.	Description	Length	Weight
C3090032	Probe w/3 5-ft. extensions	20'	21½ lb.

### Accessories

Catalog No.	Description	Weight
C3090033	5-ft. extension only	3 lb.

## SOIL CLASSIFICATION DATA

Class	Common Soil-Type Description	Geological Soil Classification	Probe Values ft.-lb. (NM)	Typical Blow Count "N" per ASTM-D1586
0	Sound hard rock, unweathered (bedrock)	Granite, Basalt, Massive Limestone	N.A.	N.A.
1	Very dense and/or cemented sands; coarse gravel and cobbles	Caliche, (Nitrate-bearing gravel/rock),	over 60 (85 - 181)	60-100+
2	Dense fine sands; very hard silts and clays (may be preloaded)	Basal till; boulder clay; caliche; weathered laminated rock	over 50 (68 - 85)	45-60
3	Dense sands and gravel; hard silts and clays	Glacial till; weathered shales, schist, gneiss and siltstone	42 - 50 56 - 68	35-50
4	Medium dense sand and gravel; very stiff to hard silts and clays	Glacial till; hardpan; marls	33 - 42 (45 - 56)	24-40
5	Medium dense coarse sands and sandy gravels; stiff to very stiff silts and clays	Saprolites, residual soils	25 - 33 (34 - 45)	14-25
6	Loose to medium dense fine to coarse sands to stiff clays and silts	Dense hydraulic fill; compacted fill; residual soils	17 - 25 (23 - 34)	7-14
**7	Loose fine sands; Alluvium; loess; medium - stiff and varied clays; fill	Flood plain soils; lake clays; adobe; gumbo, fill	8 - 17 (11 - 23)	4-8
**8	Peat, organic silts; inundated silts, fly ash very loose sands, very soft to soft clays	Miscellaneous fill, swamp marsh	under 8 (0 - 11)	0-5

Class 1 soils are difficult to probe consistently and the ASTM blow count may be of questionable value.

\*\*It is advisable to install anchors deep enough, by the use of extensions, to penetrate a Class 5 or 6, underlying the Class 7 or 8 Soils.



C3030115



T3030166

## BOLT CIRCLE ADAPTERS (For torques up to 10,000 ft.-lb.)

These adapters are used to connect two tools having incompatible bolt circles. The C3030115 is for use between two tools having tapped 5 1/4" bolt circles.

The T3030166 is for use between a tool having a 5 1/4" bolt circle and one having a 7 5/8" bolt circle.

Both are limited to 10,000 ft.-lb.

Cat. No.	Description	Wt., lb.
C3030115	Bolt circle adapter with two 1/2" x 5 1/4" bolt circles	11
T3030166	Bolt circle adapter with one 1/2" x 5 1/4" bolt circle and one 5/8" x 7 5/8" bolt circle	18

## EXPANDING & TAMPING BAR

The Chance fiberglass handle Expanding and Tamping Bar simplifies the job of expanding anchors. The curved Expander and Tamper Head distributes the weight of the bar evenly around the anchor rod to reduce handle vibration. The hook of the Expanding and Tamping Bar wraps around the anchor rod to keep the expanding head from slipping off the anchor top plate. This tool is also effectively used for tamping in soil above the installed anchor. The base casting is attached directly to the fiberglass handle.



Fiberglass Handle

Expander and Tamper Head

Cat. No.	Description	Length	Weight
C3020003	Expanding & Tamping Bar	10'	22 lb.
C3020004	Expanding & Tamping Bar	12'	24 lb.
*E3020001P	Fiberglass Handle	10'	7 lb.
*E3020006P	Fiberglass Handle	12'	8 lb.
P3020002P	Expander and Tamper Head	N/A	14 lb.

\*Includes plug mix to reset handle.

## STANDARD PULLING EYE

This inexpensive cost-cutter provides a large offset eye to accommodate three-ton chain hoist hooks, and leaves the anchor eye free with plenty of clearances for attaching formed wire grips. By removing the Adapter Bushing, the E96 Pulling Eye fits 1 1/4" rods. The E96 Pulling Eye is inexpensive and easy to use. One person can assemble and hook up in minutes.

For working loads to approximately 6,000 pounds (ultimate strength — 18,000 pounds).

Catalog No.	Description	Weight
E96	Pulling Eye, Bolt, Nut	5 lb.
C3031661	Bolt, Nut, Adapter	1 lb.

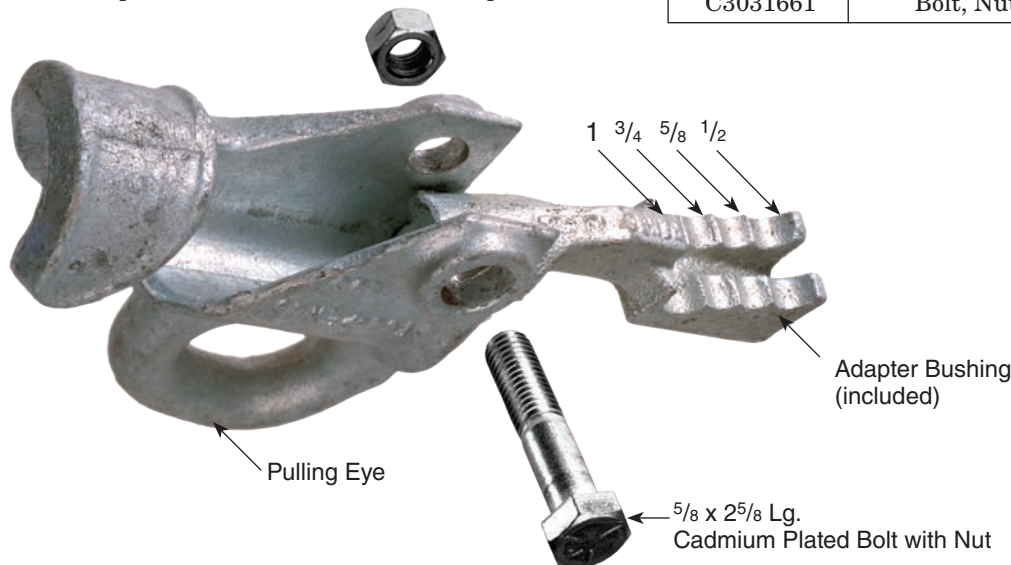

Pulling Eye

Adapter Bushing (included)

5/8 x 2 5/8 Lg. Cadmium Plated Bolt with Nut



# Portable Anchor Installers for small foundations

2,500 ft.-lb. torque capacity hydraulic power drive

**Economical manual operation and portability  
for remote sites, common anchor installations**

For most shaft-driven guy anchors and smaller screw foundations, these compact drivers get into areas where large equipment cannot go or is impractical. Operator does not need to resist the torque generated by anchor installation. Countertorque transmits through a torque bar from the drive head to the earth or other restraint. This frees the operator for the task of guiding the anchor path.

Built-in bypass valve limits output to 2,500-ft.-lb. maximum, two-way foot pedal gives operator direct control over drive and reverse directions, hoses (two 12-ft. and two 25-ft.) come with quick couplers for all connections from power supply to foot control to drive head. Pivoting drive-head yoke connects with bent-arm pin to square-tubular torque bar which telescopes from 8 feet to 10 feet as needed.

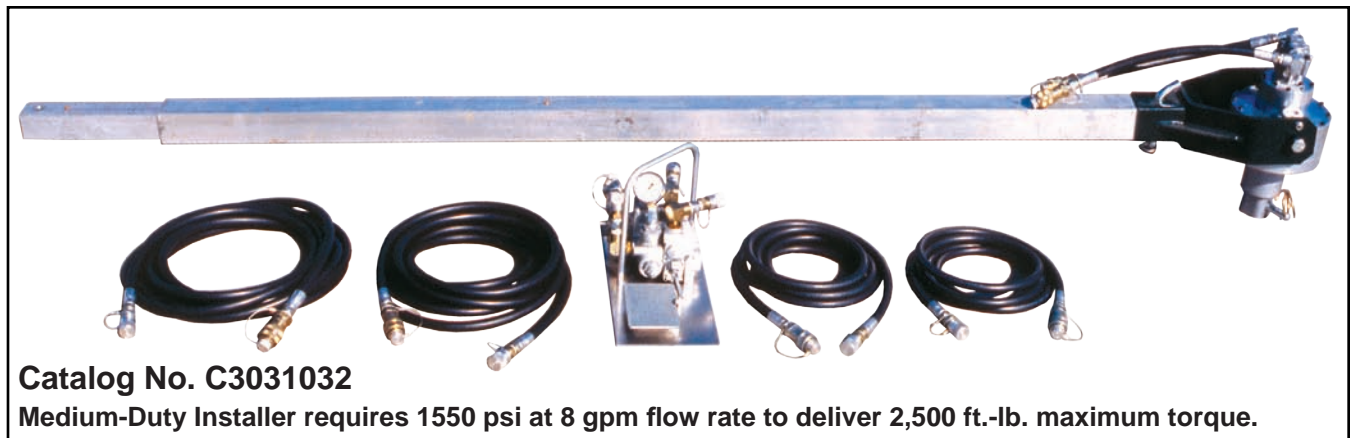

**Catalog No. C3031032**

Medium-Duty Installer requires 1550 psi at 8 gpm flow rate to deliver 2,500 ft.-lb. maximum torque.

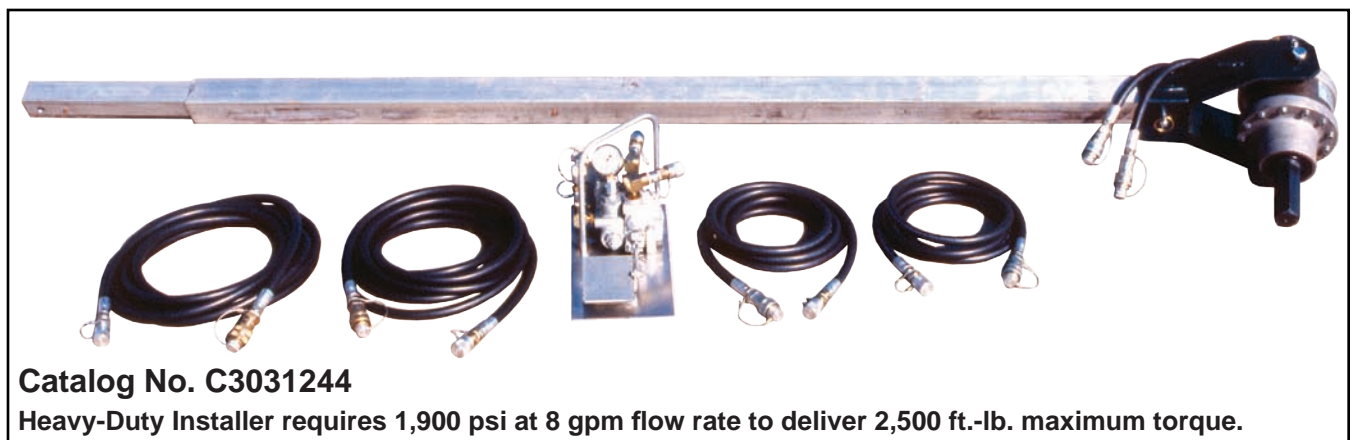

**Catalog No. C3031244**

Heavy-Duty Installer requires 1,900 psi at 8 gpm flow rate to deliver 2,500 ft.-lb. maximum torque.

**B**

# 2,500 ft-lb Portable Anchor Installers

## †Medium Duty — Catalog No. C3031032

<b>Grease filled gear case. Single Catalog Number above includes all items below. Each item also may be ordered by separate number.</b>	
* Hydraulic Control Valve	C3031031
Two 25-ft. Hydraulic Hoses	C4176121 (each)
* Hydraulic Drive Head	C3031180
Yoke Assembly	E3030680
* Two 12-ft. Hydraulic Hoses	E3030876 (pair)
Square Torque Bar Assembly	E3031041

Output shaft is 1½" square socket. Requires C3031230 and flanged drive tool (order separately) to install anchors other than 1½" square 1¼" round shaft.

\* Note: Hydraulic components are not interchangeable between C3031032 and C3031244.

## Heavy Duty — Catalog No. C3031244

<b>Sealed oil-filled gear case. Single Catalog Number above includes all items below. Each item also may be ordered by separate number.</b>	
* Hydraulic Control Valve	C3031247
Two 25-ft. Hydraulic Hoses	C4176121 (each)
* Hydraulic Drive Head	C3031233
Yoke Assembly	E3030680
* Two 12-ft. Hydraulic Hoses	E3031253 (pair)
Square Torque Bar Assembly	E3031041

Output Shaft is 2" Hex. - Requires Kelly Bar Adapter P630013 and flanged drive tool (order separately) to install all anchors.

\* Note: Hydraulic components are not interchangeable between C3031032 and C3031244.

### Anchor Drive Tools

See page 8 for details on tools to drive specific anchor types.



†Adapter Tool  
Catalog  
No. C3031230

†Note that all 5¼" bolt-circle tools may be connected directly to Heavy Duty Portable Anchor Installer Cat. No. C3031244. †Adapter Tool Cat. No. C3031230 is required to connect 5¼" bolt-circle tools to Medium Duty Portable Anchor Installer Cat. No. C3031032. If needed, order Adapter C3031230 as a separate item.

## Optional Hydraulic Power Unit Catalog No. C3031201

For easy wheeling to worksite, hydraulic drive head and foot control secure by rubber strap included to angle braces atop the cart frame and hoses ride on handles.

Cart-mounted on 5/8"-diameter axle with two 4.80 x 8 inflatable (30psi) tires; 27¼" wide x 34½" high x 36" long; shipping weight with oil: 275 lb.

Hydraulic Pump with fan cooling system:

Typical output pressure 2500psi  
Pump displacement 8 gpm @ 3400rpm  
Reservoir capacity 5 gallons US  
(shipping cap and vented fill cap provided)

Gasoline Engine System:

16hp Briggs & Stratton  
Industrial/Commercial Model 326437, Type 2527  
12-Volt pushbutton start, 3600rpm (maximum)

Operating instructions are included with anchor installer and hydraulic power unit.



# Anchor/Foundation Drive Heads

- Vehicle Mounted
- Hydraulic Powered
- 6,000 & 11,500 ft.-lb. Torque Ratings

Specially suited for vertical installations of screw-type anchors, foundations, and bumper posts.

The drive head comes in two torque-rating ranges. The design also delivers other features for rugged field conditions.

- Precision planetary gears and bearings in oil-filled, sealed gearcase
- Heavy-duty output housing and bearings
- Heavy-duty bail flange mounted to gearcase housing provides balanced load-sharing torque restraint
- Dual-pin mounting provides drive-head positioning for controlled installations
- Drive-head also readily accepts earth augers for hole digging

Hose assemblies are not furnished with drive heads. For hydraulic flow more than 20 gpm, 3/4"-diameter hose is recommended. For flow rates of 20 gpm and below, 1/2" hose may be used. Swivel joint and swivel joint adapter are furnished. Thread size is 1"-11 1/2" NPSM (National Pipe Straight Mechanical).



## Skid-Steer Utility Plate, Bail and Jib Components

To order, refer to information below and on next page. Specify one each: Drive Head, Utility Plate, Bail & Jib Assembly, and Kelly Bar Adapter.

6,000 ft.-lb. maximum torque

For **Bobcat Skid-Steers ONLY:**

Catalog No.	Description
C3031014	6,000 ft.-lb. Utility Plate, Bail & Jib Assembly

For Skid-Steers *other than Bobcat:*

(for field welding to utility plates on skid-steers)

C3031016	3,500 ft.-lb. Bail & Jib Assembly less Utility Plate
----------	--

Catalog Numbers at left do not include drive head, hoses or kelly bar adapter as shown at right.



## Backhoe Mounting Components

To order, specify components in Typical Tool-String Assemblies on next page.

6,000 and 11,500 ft.-lb. maximum torque

†Backhoe Mounting Brackets

Dimensions, inches		Backhoe Brand Name	Catalog Number	Bracket Description
*A	B			
10.1	1.5	Case	C3030969	6K & 11.5K ft.-lb. Eskridge
10.1	1.0	Case	C3030970	3.5K ft.-lb. Eskridge
7.00	1.5	JCB	C3030971	6K & 11.5K ft.-lb. Eskridge
7.00	1.0	JCB	C3030972	3.5K ft.-lb. Eskridge
8.18	1.5	John Deere	C3030973	6K & 11.5K ft.-lb. Eskridge
8.18	1.0	John Deere	C3030974	3.5K ft.-lb. Eskridge

\*Bracket accepts boom up to 10.2" wide (1.75" dia. pin).

For booms 7" & 8.18" wide, 2 spacer bushings supplied. Other bushings available for backhoes not listed.

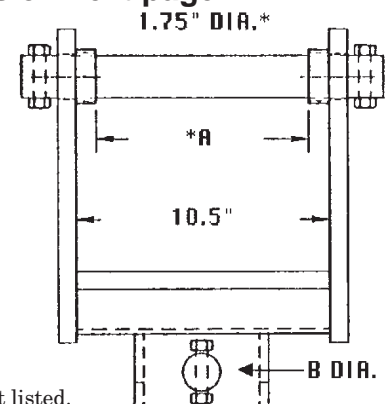

# Typical Backhoe Tool-Strings

**For SS5 and SS150 (1½" Square Shaft) Series Anchors**

Headroom Dimension	Drive Head, ft.-lb.
52 <sup>5</sup> / <sub>8</sub> "	6,000
52 <sup>5</sup> / <sub>8</sub> "	11,500

**For SS175 (1¾" Square Shaft) Series Anchors**

Headroom Dimension	Drive Head, ft.-lb.
56 <sup>3</sup> / <sub>4</sub> "	6,000
56 <sup>3</sup> / <sub>4</sub> "	11,500

## Anchor/Foundation Drive Heads

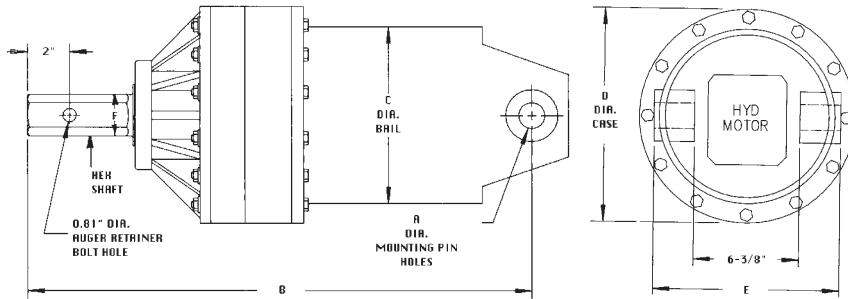

### †Kelly Bar Adapters

Each of these Kelly Bar Adapters has a 5¼" bolt circle and comes with (6) ½" bolts, nuts and lock-washers and a Bent-Arm Pin with Coil Lock (see page 4A-7).

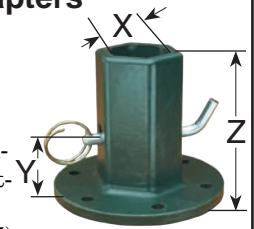

Part No.	X	Y	Z
630013	2" Hex	5"	6 <sup>1</sup> / <sub>8</sub> "
630011HD	2½" Hex	4 <sup>1</sup> / <sub>4</sub> "	8 <sup>1</sup> / <sub>8</sub> "

**Output Torque vs. Pressure**

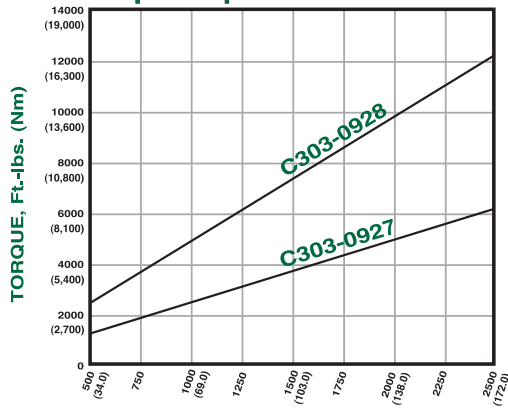

PRESSURE, psi (BARS)-Drop Across Motor

**Output Speed vs. Flow**

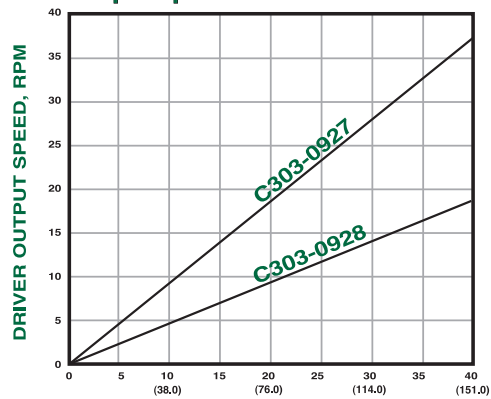

FLOW RATE, gpm (lpm)

Catalog Number	Running Torque ft.-lb.	Running Torque Nm	Flow gpm	Speed rpm	Wt. lb.	Wt. kg	Dimensions (in., cm)											
							A	B	C	D	E	F						
C3030927	6,000 @ 2,400 psi	8,100 @ 165 BARS	40	39	246	112	1.5	3.81	29.5	74.9	10.7	27.2	13	33.0	11.4	28.9	2.5	6.4
C3030928	11,500 @ 2,400 psi	15,600 @ 165 BARS	40	20	246	112	1.5	3.81	29.5	74.9	10.7	27.2	13	33.0	11.4	28.9	2.5	6.4

# APPLICATION AND INSTALLATION GUIDES

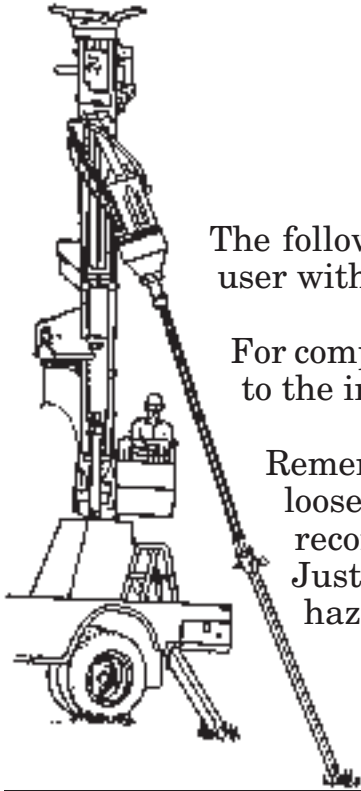

The following installation procedures have been written to familiarize the user with basic knowledge on how the chosen anchor is to be used.

For complete installation instructions and safety information, always refer to the instruction sheets provided with the drive tooling.

Remember, before starting any anchor job, inspect the tooling for wear or loose and missing parts. If replacement is necessary, only use CHANCE® recommended parts.

Just as equally important, inspect and survey the worksite for safety hazards.

**B**

## Table of Contents

B-45	TOUGH ONE® Anchors
B-46	Standard PISA® Anchors
B-47	How to Use PISA® Anchors
B-48	Square Shaft and Round Rod Anchors
B-49	No Wrench Anchors
B-50	Corrosion Resistant Disk Anchors
B-51	8-Way Expanding (Bust) Anchors
B-52	Cross Plate Anchors
B-53	Pole Key Anchor
B-54	Expanding Rock Anchors
B-55	Bumper Post Anchors
B-56	How to Solve Anchor Problems
B-61	Tool Maintenance - Inspections
B-64	Anchor Tooling - Proper Maintenance
B-68	Anchor Installing Tool Safety - “Proper Tooling”
B-71	Tool Maintenance - “Detecting and Preventing Damaged Tooling”

This section of the Anchor Encyclopedia is to provide basic data on how and when a certain anchor is to be used. Always refer to the actual supplied instructions for preferred installation techniques.

# APPLICATION/INSTALLATION TOUGH ONE® ANCHORS

## 15,000 FT-LB. LARGE HUB ASSEMBLIES

## 10,000 FT-LB. LARGE HUB ASSEMBLIES

<b>ANCHOR APPLICATIONS</b>	For distribution and transmission guy loads, 3½ and 7 foot anchor rods are used.	For distribution and transmission guy loads, 3½ and 7 foot anchor rods are used.
<b>INSTALL IN THESE CLASS SOILS</b>	Classes 1, 2, 3, 4 and 5 (300-1600 inch-pounds with the soil test probe)	Classes 2, 3, 4 and 5 (300-750 inch-pounds with the soil test probe)
<b>INSTALLING EQUIPMENT REQUIRED</b>	Power digger and wrench assembly (see page B-28)	Power digger and wrench assembly (see pages B-26 or B-28)
<b>LIMITATIONS ON USE</b>	Do not use beyond two extensions (14 feet). Maximum installation torque is 15,000 foot-pound.	Do not use beyond two extensions (14 feet). Maximum installation torque is 10,000 foot-pound.

## 10,000 FT-LB. SMALL HUB ASSEMBLIES

## 8,000 FT-LB. SMALL HUB ASSEMBLIES

<b>ANCHOR APPLICATIONS</b>	For distribution and transmission guy loads, 3½ and 7 foot anchor rods are used.	For distribution and transmission guy loads, 3½ and 7 foot anchor rods are used.
<b>INSTALL IN THESE CLASS SOILS</b>	Classes 2, 3, 4 and 5 (300-750 inch-pounds with the soil test probe)	Classes 2, 3, 4 and 5 (300-750 inch-pounds with the soil test probe)
<b>INSTALLING EQUIPMENT REQUIRED</b>	Power digger and wrench assembly (see page B-26)	Power digger and wrench assembly (see page B-26)
<b>LIMITATIONS ON USE</b>	Do not use beyond two extensions (14 feet). Maximum installation torque is 10,000 foot-pound.	Do not use beyond two extensions (14 feet). Maximum installation torque is 8,000 foot-pound.

# APPLICATION/INSTALLATION

## PISA® ANCHORS

### STANDARD STRENGTH ANCHORS

### MID-STRENGTH ANCHORS

<b>ANCHOR APPLICATIONS</b>	For distribution guy loads, 3½ and 7 foot anchor rods are used.	For distribution and sub-transmission guy loads, 3½ and 7 foot anchor rods are used.
<b>INSTALL IN THESE CLASS SOILS</b>	Classes 5 and 6 (200-400 inch-pounds with the soil test probe)	Classes 4, 5 and 6 (200-500 inch-pounds with the soil test probe)
<b>INSTALLING EQUIPMENT REQUIRED</b>	Power digger and wrench assembly (see page B-26)	Power digger and wrench assembly (see page B-26)
<b>LIMITATIONS ON USE</b>	Do not use in hard soils beyond two extensions (14-feet). Maximum installation torque is 4,000 foot-pound.	Do not use in very hard soils or beyond two extensions (14-feet). Maximum installation torque is 6,000 foot-pound.

### PISA®-6 ANCHORS (FORMERLY PISA®-5 ANCHORS)

### PISA®-7 ANCHORS

<b>ANCHOR APPLICATIONS</b>	For distribution and sub-transmission guy loads, 3½ and 7 foot anchor rods are used.	For distribution and transmission guy loads, 3½ and 7 foot anchor rods are used.
<b>INSTALL IN THESE CLASS SOILS</b>	Classes 4, 5 and 6 (200-500 inch-pounds with the soil test probe)	Classes 2, 3, 4 and 5 (300-750 inch-pounds with the soil test probe)
<b>INSTALLING EQUIPMENT REQUIRED</b>	Power digger and wrench assembly (see page B-26)	Power digger and wrench assembly (see page B-26)
<b>LIMITATIONS ON USE</b>	Do not use in very hard soils or beyond two extensions (14-feet). Maximum installation torque is 6,000 foot-pound.	Do not use in hard, rocky soils or beyond two extensions (14-feet). Maximum installation torque is 7,000 foot-pound.

# HOW TO USE POWER-INSTALLED SCREW ANCHORS

## GENERAL INSTALLATION CONSIDERATIONS

Four words summarize proper anchor installation technique: “proper alignment” and “down pressure.” The PISA® anchor wrench transmits torque from the digger’s Kelly bar to the anchor hub. (The anchor rod only has to be of sufficient diameter to support the guy load.) Always maintain adequate down pressure and keep the Kelly bar and the wrench aligned with the anchor. The right amount of down pressure keeps the anchor continuously advancing. Too much down pressure may bend or even break an anchor helix at torque loads far below the rating. Too little down pressure may result in “churning” the soil, damaging the wrench and possibly damaging the digger truck. Either extreme may result in wasted time, reduced holding capacity and damaged equipment.

## FOR SITUATIONS WHERE OVERHEAD LINES ARE NOT AN OBSTRUCTION

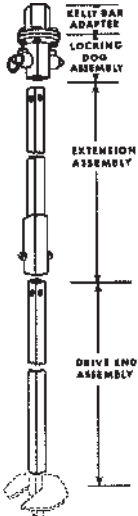

## STEP-BY-STEP ANCHOR INSTALLATION PROCEDURE

### ANCHOR WRENCH

Kelly bar adapter is attached to digger’s Kelly bar by a single bolt. Locking dog assembly holds the drive end assembly. If anchor depth of one 7’ rod length is desired, drive end assembly is all that’s required. If anchor is to be installed deeper than one anchor rod length, the 3 1/2’ extension assembly is attached between drive end assembly and locking dog assembly to obtain added depth. PISA® anchors should not be installed beyond 14’ since wrench retrieval is difficult beyond this depth.

### STEP ONE — OPEN LOCKING DOGS

Before installing drive end assembly in locking dog assembly, open dogs by pulling outward and twisting to outside position. NOTE: Locking dog assembly has three ring positions. Middle position holds wrench drive end assembly. Inside ring position allows locking dogs to hold anchor rod. Outside position releases drive end assembly from locking dog assembly.

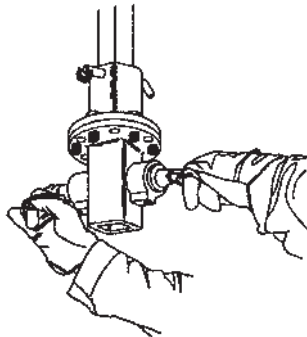

### STEP TWO — INSERT DRIVE END ASSEMBLY

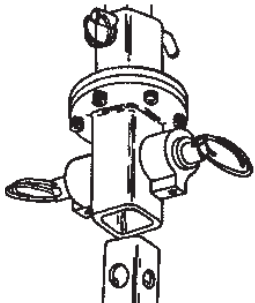

With locking dog rings in outside position, insert drive end assembly into locking dog assembly. Rotate rings to middle position. Drive end assembly will be captured in locking dog assembly. Now rotate locking dogs to inside position to accept and capture anchor rod.

### STEP THREE— INSERT ANCHOR ROD IN DRIVE END ASSEMBLY

Because locking dogs are now at inside position, assembly will hold anchor rod. Screw rod into the threads located in the hub of the anchor helix. Insert rod into drive end assembly with an upward thrust.



### STEP FOUR—LOCKING ANCHOR IN PLACE

With strong upward motion, lock anchor into wrench. Locking dogs, properly closed to inside position, will hold anchor rod in wrench.

### STEP FIVE—INSTALL ANCHOR

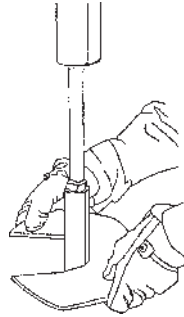

Begin anchor in near vertical position. When anchor has a good start, retract boom to correct anchor angle. Complete installation. During installation, truck outriggers should lift slightly. Avoid excessive uplift. When locking dogs reach ground level, stop installation.

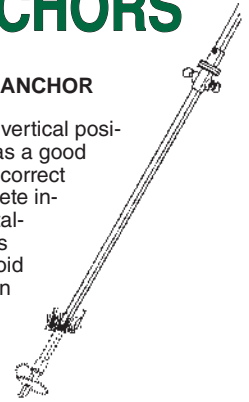

### STEP SIX—RETRIEVE WRENCH

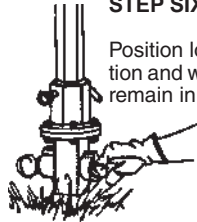

Position locking dog rings in middle position and withdraw wrench. Anchor rod will remain in ground.



### STEP SEVEN— ATTACH ANCHOR EYE NUT

## FOR AN INSTALLATION DEEPER THAN ONE ANCHOR ROD LENGTH, PERFORM FOLLOWING STEPS

### REMOVE LOCKING DOG ASSEMBLY AT GROUND LEVEL

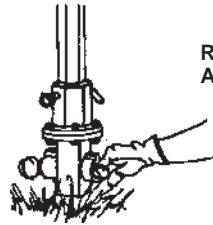

Position locking dog rings in outside position and withdraw locking dog assembly.

### ADD ANCHOR ROD EXTENSION

Add anchor extension rod to rod remaining in ground.

### ATTACH WRENCH ASSEMBLY

With wrench extension bolted to drive end assembly in the ground and locked in position at the locking dogs, installation can proceed.

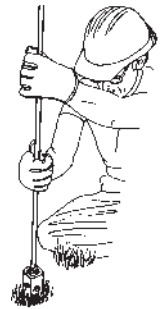

### COMPLETE THE INSTALLATION

When locking dogs reach ground level, position locking dogs in middle position and retrieve the drive end assembly and extension assembly.

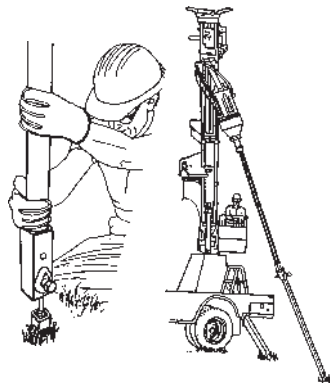

Attach anchor eye nut and the installation is complete

**NOTE:** Always refer to the actual supplied tooling instructions before any installation as conditions may require a modification in practiced methods.



# APPLICATION/INSTALLATION

## TYPE SS SQUARE SHAFT AND TYPE RR ROUND ROD ANCHORS

### TYPE SS 5 ANCHORS

### TYPE RR ANCHORS

<b>ANCHOR APPLICATIONS</b>	For transmission guy loads, 3½, 5, 7 and 10 foot extensions are used.	For distribution and transmission guy loads. 3½, 5, 7 and 10 foot extensions are used.
<b>INSTALL IN THESE CLASS SOILS</b>	Classes 2, 3, 4, 5 and 6 (200-750 inch-pounds with soil test probe)	Classes 5, 6 and 7 (100-400 inch-pounds with soil test probe)
<b>INSTALLING EQUIPMENT REQUIRED</b>	Power digger and wrench assembly (see page B-30)	Power digger and wrench assembly (see page B-30)
<b>LIMITATIONS ON USE</b>	Not normally recommended for depths beyond 100 feet. Do not exceed maximum torque rating of anchor.	Not recommended for use beyond 35 feet. Maximum installation torque is 2300 foot-pounds.

**B**

### INSTALLATION GUIDE

Once all safety concerns have been addressed, attach the Kelly bar adapter and installing tool assembly to the Kelly bar on the installing truck.

Insert the upper end of the anchors' lead section into the installing tool. Position the anchor at the desired guy location and at a near vertical position; screw the first helix into the ground.

When the first helix is buried, begin to make the angular adjustment for the desired guying angle.

Remember, final angular adjustments should be made before the second helix penetrates the ground.

When the installing tool becomes 12"-18" from the ground, disconnect it from the section in the ground and reconnect it to the next extension.

Align the extension with the section in the ground and bolt them together. (Make certain that the bolt and nut are securely tightened.)

Continue to drive the anchor and add extensions until the desired torque is reached and maintained for a minimum of three feet or three times the diameter of the largest helix.



A minimal installation depth of three times the diameter of the largest helix (below the freeze/thaw line) is required. This depth should equal or exceed five times the diameter of the largest helix from the top surface of the soil vertically.

If this cannot be achieved (while still maintaining an adequate safety margin below the anchor's minimum ultimate torsional strength, the anchor should be removed and replaced with an anchor having smaller or fewer helices. The replacement anchor should be installed at least 5 feet from the first installation site.

Although SS anchors can be installed over 100 feet deep, one should always consider the economics of using a shallower anchor with more or larger helices or extensions with helices.

If the desired protrusion from the ground cannot be achieved without exceeding the rated torque, the last extension may be replaced with a shorter extension by excavation along the rod to the coupling bolt, but never by unscrewing the anchor.

When the anchor reaches the desired setting the guy adapter is attached using the same attachment method as the extensions. The guy wire should not be attached to the guy adapter pulling eye.



# APPLICATION/INSTALLATION

## NO-WRENCH ANCHORS

<b>ANCHOR APPLICATIONS</b>	For distribution guy loads. Extensions available.
<b>INSTALL IN THESE CLASS SOILS</b>	Classes 5, 6 and 7 (100-300 inch-pound with the soil test probe)
<b>INSTALLING EQUIPMENT REQUIRED</b>	Install by hand using a turning bar or a power digger. Using a digger, adapter and installing tool is required. (see page B-30)
<b>LIMITATIONS ON USE</b>	Can only be installed in relatively soft soils. Maximum installing torque 2300 foot pounds.

### STEP #1 (POWER DIGGER)

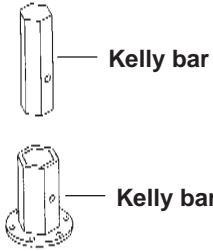

Attach the appropriate Kelly bar adapter to the digger's Kelly bar (output shaft).

### STEP #2 (POWER DIGGER)

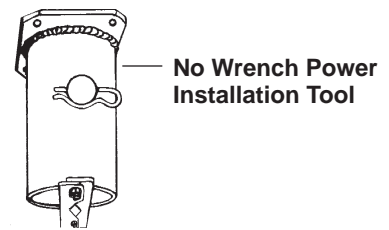

Bolt the no-wrench power installation tool to the Kelly bar adapter.

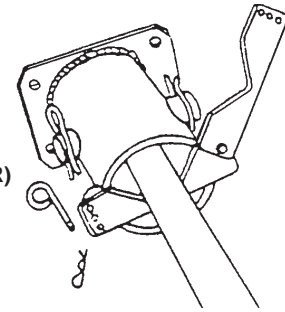

### STEP #3 (POWER DIGGER)

Remove the appropriate pins in the No-Wrench anchor installation tool. Insert anchor rod eye into the tool and re-pin to the appropriate settings.

### STEP #4 (POWER DIGGER)

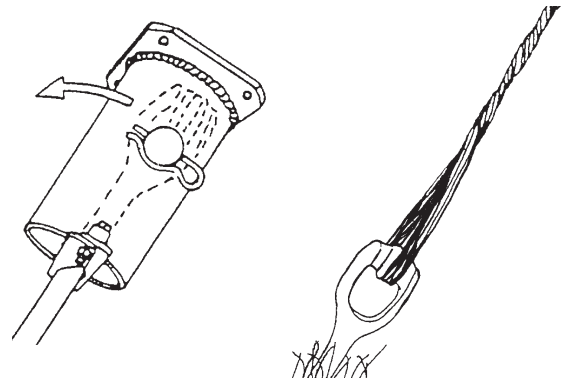

Start driving the anchor at a near vertical position. Once the anchor's helix is below ground, retract the boom to the correct guy angle.

**NOTE:** When installation is complete, make certain that the eye of the anchor is in the correct position for guying before removing the installation tool from the anchor.

### INSTALLATION GUIDE:

#### STEP #1 (BY HAND)

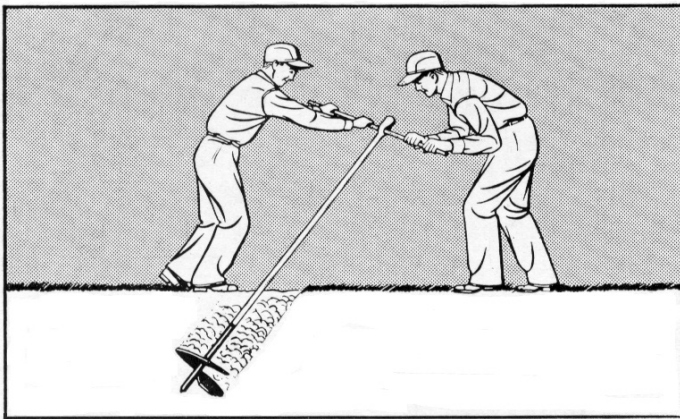

Insert turning bar into the opening of the forged eye on the rod and screw anchor into ground.

**NOTE:** For harder soils, a small, shallow pilot hole dug with a shovel may be required to get anchor started.

# APPLICATION/INSTALLATION CORROSION RESISTANT DISK ANCHORS

<b>ANCHOR APPLICATIONS</b>	For alkali, acid and soils with electrolyte combinations.
<b>INSTALL IN THESE CLASS SOILS</b>	Classes 3, 4, 5, 6 and 7 (100-600 inch-pound with the soil test probe)
<b>INSTALLING EQUIPMENT REQUIRED</b>	Power digger, rod trenching tool, shovel and tamping bar.
<b>LIMITATIONS ON USE</b>	Necessity of undercutting hole limits anchor depth. Rod trench should not be large or hold capacity will be reduced. Both anchor hole and rod trench must be backfilled and tamped.

## STEP #3

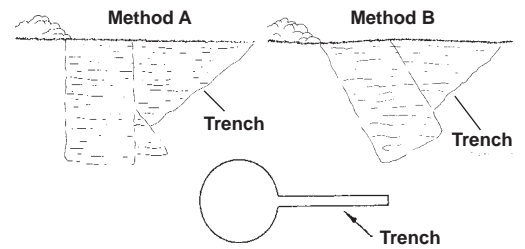

Cut a rod trench with a trenching tool or a small auger.

**NOTE:** Trench should be narrow to avoid disturbing soil.

## STEP #4

Assemble the components making sure that the curved surface of the washer is against the curved surface of the anchor and the flat side of the washer is against the flat surface of the nut. Care should be taken not to damage the plastic tube on the rod.

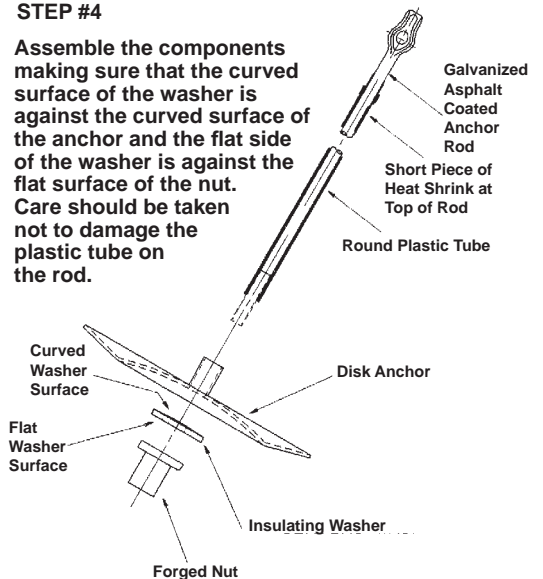

## INSTALLATION GUIDE:

### STEP #1

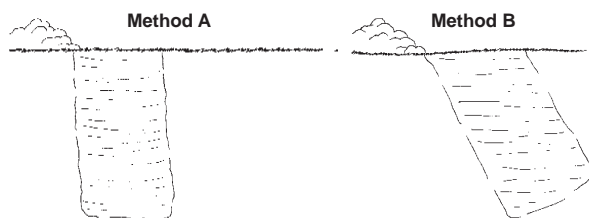

Drill a vertical hole or angled hole.

### STEP #2

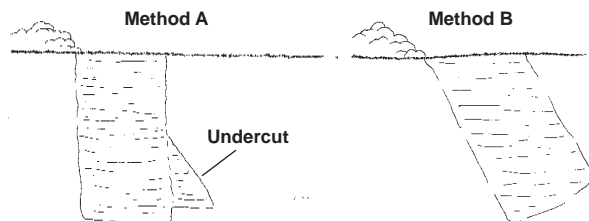

Undercut the hole so that the anchor plate can be installed at a right angle to the guy.

### STEP #5

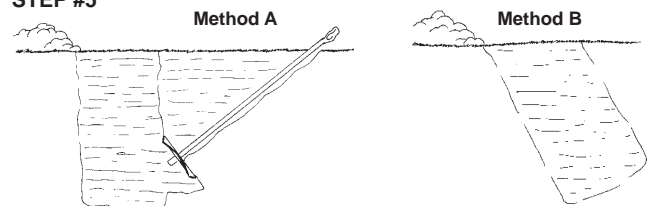

Install anchor in hole so rod is aligned within  $\pm 10$  degrees of the guy so that strength of the installation is not reduced.

### STEP #6

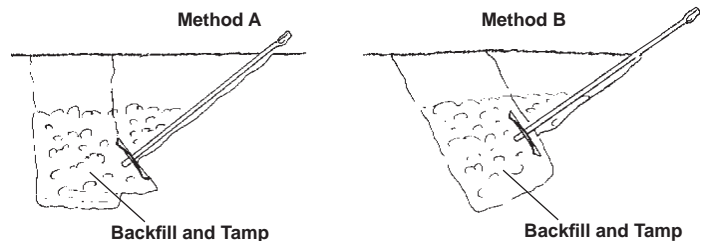

Thoroughly backfill and tamp the anchor hole and rod trench.

# APPLICATION/INSTALLATION

## EXPANDING 8-WAY ANCHORS

<b>ANCHOR APPLICATIONS</b>	For distribution guying. Use to depths of 12 feet.
<b>INSTALL IN THESE CLASS SOILS</b>	Classes 3, 4, 5, 6 and 7 (100-600 inch-pound with the soil test probe)
<b>INSTALLING EQUIPMENT REQUIRED</b>	Hand or power auger. Expanding and tamping bar or mechanical tamper and shovel. (See page B-33)
<b>LIMITATIONS ON USE</b>	Depends on backfill effectiveness. Difficult to tamp in wet or plastic soil after rain. Seeping ground water can cut holding capacity 50 percent.

STEP #2

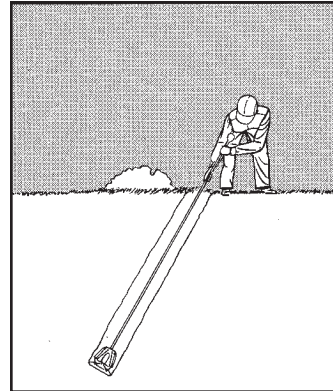

Attach rod to anchor and lower the assembly into the hole.

STEP #3

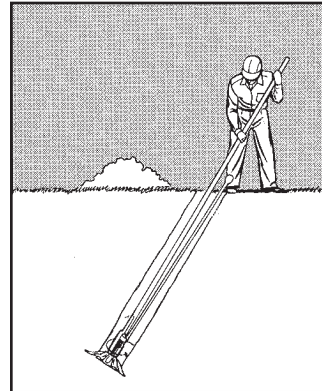

Expand the anchor with the expanding bar by striking the top plate.

**NOTE:** The expanding bar should be rotated around the anchor during the busting process.

STEP #4

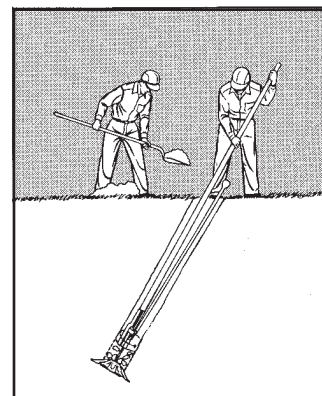

Backfill and tamp hole.

### INSTALLATION GUIDE:

STEP #1

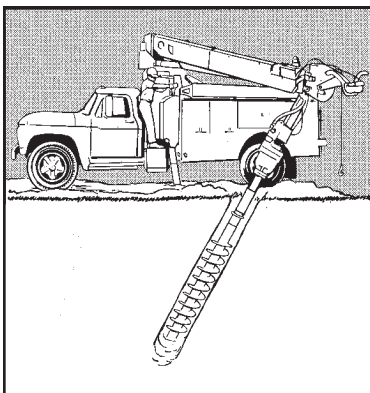

The hole should be drilled at a 45° to 60° angle in line with the guy.

**NOTE:** Hole size should be slightly larger than the unexpanded anchor. See chart on page B-20.

# APPLICATION/INSTALLATION

## CROSS PLATE ANCHORS

<p><b>ANCHOR APPLICATIONS</b></p>	<p>For medium and heavy transmission guying. Installed in machine bored holes. Load-based on using a 400 square inch anchor to a 24" hole.</p>
<p><b>INSTALL IN THESE CLASS SOILS</b></p>	<p>Classes 3, 4, 5, 6 and 7 (100-600 inch-pound with the soil test probe)</p>
<p><b>INSTALLING EQUIPMENT REQUIRED</b></p>	<p>Power digger, rod trenching tool, shovel and tamping bar.</p>
<p><b>LIMITATIONS ON USE</b></p>	<p>Necessity of undercutting hole limits anchor depth. Rod trench should not be large or holding capacity will be reduced. Both anchor hole and rod trench must be backfilled and tamped.</p>

STEP #3

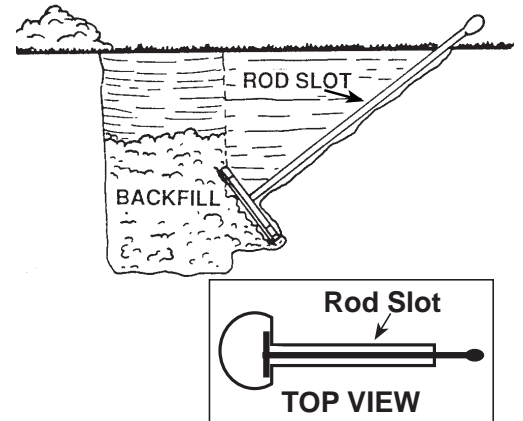

Cut a rod trench with a trenching tool or a small auger.

NOTE: Trench should be narrow to avoid disturbing soil.

STEP #4

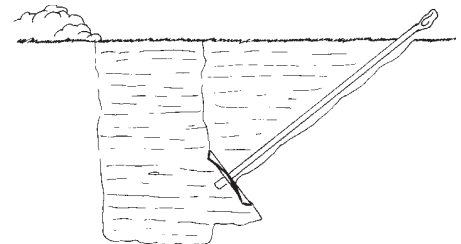

Assemble rod to anchor and install the anchor inside the hole so that the rod is aligned within  $\pm 5^\circ$  of the guy.

NOTE: Improper alignment may reduce holding capacity.

STEP #5

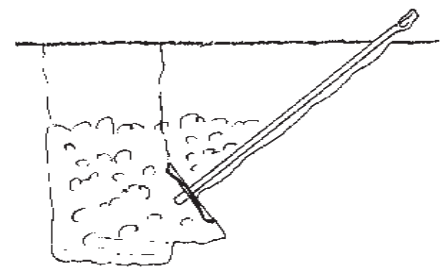

Thoroughly backfill and tamp the anchor hole and rod trench.

### INSTALLATION GUIDE:

STEP #1

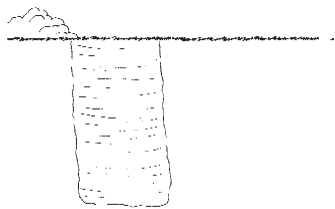

Drill a vertical or angled hole.

STEP #2

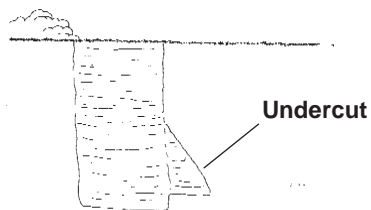

Undercut the hole so that the anchor plate can be installed at a right angle to the guy.

# APPLICATION/INSTALLATION

## EXPANDING POLE KEY ANCHOR

<p><b>ANCHOR APPLICATIONS</b></p>	<p>For reinforcing poles at the ground line where load is unbalanced in soft soils or in areas subjected to constant high winds.</p>
<p><b>INSTALL IN THESE CLASS SOILS</b></p>	<p>Classes 3, 4, 5 and 6 (200-600 inch-pound with soil test probe)</p>
<p><b>INSTALLING EQUIPMENT REQUIRED</b></p>	<p>Extra anchor rod, expanding bar and shovel. (See page B-36)</p>
<p><b>LIMITATIONS ON USE</b></p>	<p>Will not take the place of guying on a heavily-loaded structure.</p>

STEP #2

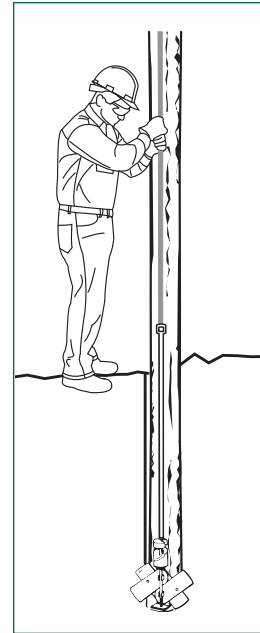

Attach anchor to rod. Lower anchor assembly into pole hole (beside the butt of pole) and bust anchor open with the Expanding/Tamping bar.

### INSTALLATION GUIDE:

STEP #1

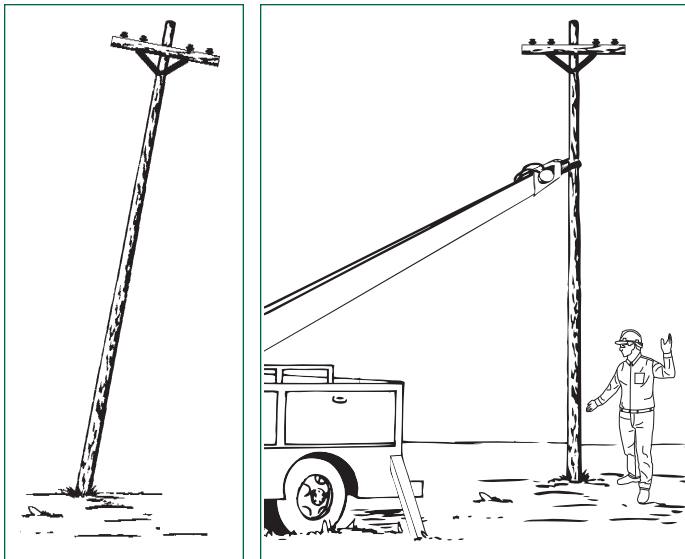

Straighten the pole.

STEP #3

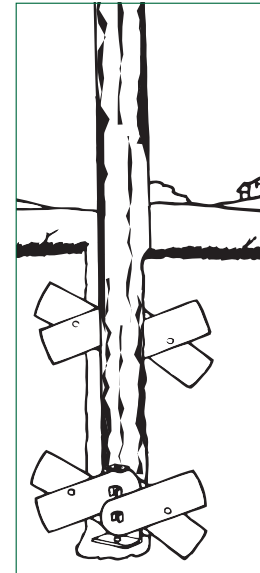

Remove rod from anchor and hole. Backfill and tamp hole.

NOTE: If desired, a second pole key anchor may be used at the top (ground level) of the hole on the opposite side of the pole.

# APPLICATION/INSTALLATION

## EXPANDING ROCK ANCHORS

<b>ANCHOR APPLICATIONS</b>	For medium-duty guying where poles are in or near rocky areas.
<b>INSTALL IN THESE CLASS SOILS</b>	Class 0.
<b>INSTALLING EQUIPMENT REQUIRED</b>	Hand or power drill and turning bar.
<b>LIMITATIONS ON USE</b>	In extremely soft rock, it may be necessary to use grouting to avoid rock crumbling which could affect holding capacity. Drilling can be a tedious job in some rock types.

STEP #2



Push the anchor assembly down inside the hole.

### INSTALLATION GUIDE:

STEP #1

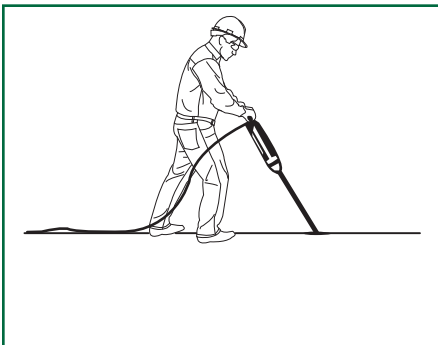

Drill the hole.

NOTE: Hole size is determined by the size of anchor used. Refer to the chart on Catalog Page B-23.

STEP #3

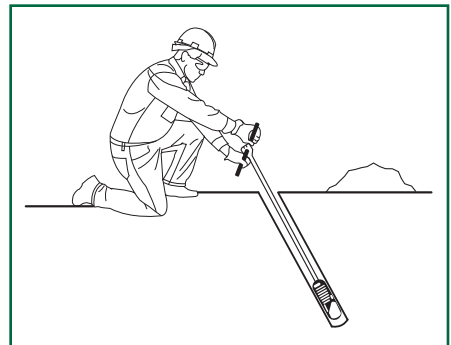

Turn the rod until the anchor is expanded tight against the sides of the hole.

Backfill and tamp hole.

# APPLICATION/INSTALLATION

## BUMPER POST ANCHORS

<b>ANCHOR APPLICATIONS</b>	Serves as instant ground protection for transformers, switchgear, guys and streetlights.
<b>INSTALL IN THESE CLASS SOILS</b>	Commonly installed through black top.
<b>INSTALLING EQUIPMENT REQUIRED</b>	Power digger and wrench assembly. (See page B-22 for required installing tools)
<b>LIMITATIONS ON USE</b>	Maximum installing torque 8,000 foot pounds.

Step #1: Assemble the drive tool to the correct Kelly bar adapter, using the six 1/2 inch diameter grade 5 bolts supplied with the tool.

Step #2: Attach the drive tool assembly to the power diggers Kelly bar, using the supplied Kelly bar adapter's bent arm pin.

Step #3: Stand the bumper post upright and slide it into the drive tool assembly.

Step #4: Raise the Kelly bar until the bumper post swings free of the ground and maneuver the assembly to the marked installation location.

Step #5: Lower the Kelly bar until the point of the bumper post sticks into the ground's surface.

Step #6: Plumb the bumper post to ensure a straight installation.

Step #7: Apply down pressure on the bumper post and rotate it in a clockwise direction.

Step #8: When the helix has penetrated approximately 1-foot, replumb the post.

Step #9: After the desired depth is reached, disconnect the bumper post from the drive tool assembly and cap.

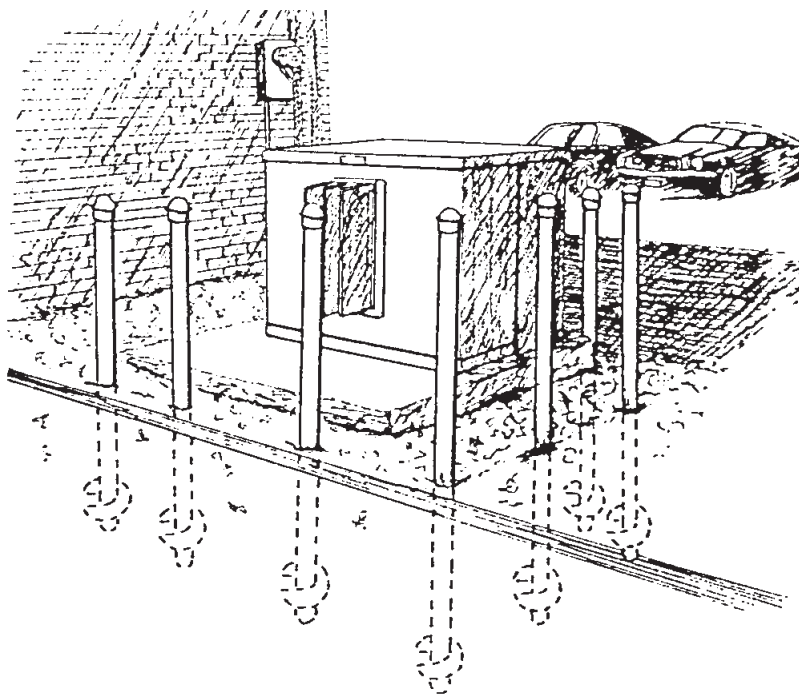



# HOW TO SOLVE ANCHOR PROBLEMS

## Know what to look for

**D**uring the rare time you do have a problem installing power-installed screw anchors (PISA®) you can turn the bad experience into a benefit that will help you avoid similar troubles in the future. The secret is analyzing exactly what happened when you encounter a problem. Look at tooling or for anchor damage caused during the installation. The damage can tell you a great deal about what went wrong, so the improper action can be avoided in the future.

One of the most common problems, particularly with PISA® anchors, is an anchor shaft fracture during installation. Because driving effort is transmitted from the anchor installing wrench to the anchor helix via the anchor shaft, if shaft stress exceeds the shaft's ultimate strength, the anchor shaft will fracture.

Fractures are not pleasant occurrences, but they tell you a great deal about what happened, and what you need to do to prevent it from happening again. If you experience a fracture, recover at least part of the anchor shaft and

observe the fracture surface. This is usually quite easily done; just withdraw the anchor rod, and you should find the top part of the anchor shaft still attached.

If the fracture surface intersects the drilled hole in the shaft (see below left), insufficient wrench engagement was the problem.

The PISA® anchor/wrench system is designed so the wrench, when

properly engaged, bridges the hollow section of the anchor shaft preventing it from having to carry any significant torsional load. If the wrench does not engage the anchor shaft sufficiently to bridge its hollow section, that section becomes the weak link in the system and fracture will occur well below the anchor's rated torsional strength. To avoid a recurrence, you may use the same type and size anchor, but be sure to screw rods all the way into the anchor and couplings; lock the anchor assembly into the wrench with the locking dogs; and follow the anchor during installation maintaining proper down pressure at all times.



Fracture problems can occur with the Square Shaft (SS) anchor if the anchor shaft is not pinned into the wrench, couplings are not properly bolted up, or they are subjected to gross misalignment. Such misalignment might be caused by leading off after encountering a hard stratum at an oblique angle or obstructions in the ground.

In either of the first two cases, the shaft tends to work its way out of the wrench or coupling. Once it gets far enough out that the drilled section is loaded torsionally, it will break well below its rated strength (see below)

In the third case, the bending moments at the joints cause gradual “belling out” of the coupling (see below) again leading to torsional loading of the drilled section and failure below rating. In all cases, the fracture surface will intersect the drilled hole. In the latter two cases, failure will usually occur below the ground line and only visual inspection of the coupling will show the difference. To avoid recurrence, make sure that the coupling bolt goes through both coupling and shaft, rather than passing above the shaft end. Pin the top shaft into the wrench during installation, and avoid misalignment along the anchor shaft or between anchor and Kelly bar.

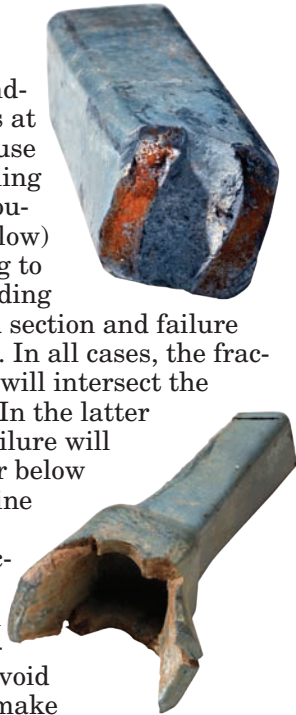

If a hard stratum at an oblique angle to the anchor’s path is the problem, change the anchor batter so that the angle is closer to 90 degrees if possible, or stop down pressuring the anchor as it reaches the stratum and allow it to auger a “pocket” which will counteract the tendency to lead off. In obstruction-laden soil, be prepared to remove the anchor, move over, and try again if the anchor starts leading off.

In the absence of engagement problems, the appearance of the shaft fracture surface is not of much significance.



The fractures shown (above right) are typical for solid shafts anchors like the SS (above). Contrary to common belief, there is no practical difference in these two types of fractures; more specifically, the Type A fracture (the above right) is not necessarily indicative of brittle shaft material. In fact, we have never seen such a fracture that was due to brittle shaft material. It is true that, for pure torsion, the Type A fracture would be typical for a brittle material while a Type B fracture (above right) would be typical for a ductile material.

However, without engagement problems, virtually all shafts fracture close to a helix where stress conditions in such areas include the non-axisymmetric structure (helix projecting from one side of shaft) and non-homogeneous mate-

rial (shaft parent metal, weld filler metal, helix parent metal, zones of intermixing, and heat-affected zone).

End restraint effects from wrench engagement and bending moments resulting from failure to maintain alignment or the anchor’s striking obstructions in the ground may also affect the stress conditions. The result is that the stress conditions causing fracture are triaxial, not torsional and Type A fractures are neither unusual nor indicative of brittle material.



Type A

Type B

It has been claimed that a helical-end wrench which engages the anchor shaft along the upper helix surface increases the torsional capacity of the anchor by forcing it into a Type A fracture which naturally has a larger fracture surface area than a Type B fracture. Actually, such wrenches offer little practical advantage because most of the time they merely force anchors to fracture the way they would have done anyway.

If you are able to rule out wrench engagement problems, there are still a couple of possibilities left. If the anchor seems to be encountering obstructions, or the operator does not seem to maintain alignment, impact loading or excessive bending moments may cause the anchor to fracture at reduced torque. Try the same type and size anchor again but with slower rotation speed and additional operator care. If on the other hand the soil seems homogeneous and the alignment is maintained properly, try a smaller or higher-strength anchor. Remember that installation torque is an



indication of soil strength, so if the torque is higher than expected, the soil must be stronger than expected and a smaller anchor should develop the load.

Another problem sometimes encountered is anchor "spinout", or rotation without axial penetration. As an anchor is rotated in the soil, the inclined plane of each helix works against the soil producing a thrust which tends to move it axially. Under perfect conditions, it will advance one pitch length per revolution and soil disturbance will be minimal. If the anchor advances more or less than one pitch per revolution, something has to give. Either the soil gets churned (likely), or the helix gets bent or torn off (not so likely).

Spinout can result from several different conditions requiring different corrective actions. You'll have to rely on observations of installation conditions and anchor damage to guide you. Take the easy case first.

If the operator fails to follow the anchor so that the digger holds back on the anchor instead of leading it, the anchor may be unable to advance at the proper rate. The soil loses strength due to the resultant churning and becomes unable to work effectively against the helical plate. Because neither the soil nor the digger is now providing the thrust, the anchor ceases to penetrate. If you're lucky, simply applying down pressure to the anchor will get it started again. Sometimes, however, the undisturbed soil below the anchor is so strong that the down pressure is not enough to restart the anchor. It may be that you can back the anchor out because the soil above it will be weaker. If not, all you can do is abandon the anchor and start over. Either way, the next step is to



move over a few feet and try again, being sure to maintain crowd this time.

Unfortunately maintaining down pressure is not a cure all. In glacial tills and other obstruction-laden soils, too much crowd can cause spinout. An anchor should be allowed to work its way through such soils with minimal down pressure. If you try to force it through, chances are fairly good that the helix leading edge will get bent (destroying its helical form and the attendant thrust) or torn off. You may or may not be able to retrieve the anchor, depending on how badly it is damaged, but you will have to replace it regardless. You might try again, using extra care to maintain

just enough down pressure to keep it penetrating. If you fail again, try an anchor with smaller or stronger (i.e., thicker or higher-strength material) helices. Or, consider Chance TOUGH ONE® anchors. They're designed for difficult soils.

Also remember it's in these obstruction-laden soils that the curvilinear leading edge really shines thanks to its tendency to guide the anchor around obstructions without hanging up and its greater resistance to bending. So if you're using anchors with straight leading edges and a curvilinear equivalent is available, try it.

Even if the operator maintains good control of crowd, keeping the anchor advancing at one pitch length per revolution, unforeseen soil conditions can still lead to spinout. The installation may be progressing nicely with little or no down pressure required when the anchor can unexpectedly encounter a hard stratum or even a large rock or other obstacle and the resistance to penetration shoots up becoming greater than the combined crowd and thrust. The anchor may

spin out before the operator can react and then refuse to start advancing again.

In such cases you can usually retrieve the anchor. Look for abrasion or gouging on lower surfaces to confirm the problem, then move over and try again.

This time be prepared to apply heavy down pressure on the anchor at the first sign of extra resistance. If it still doesn't go, try using more, smaller helices or, if the problem area isn't too thick, predrilling through it. In the latter case, be sure the upper helix is driven at least five times its diameter deeper than you predrilled.

Yet another way an installation attempt may fail is refusal where the torque required for continued penetration exceeds the capacity of the digger, but not that of the anchor. In such cases everything comes to a halt. As with the previous cases, there is not a single, universal fix for this circumstance. The next step depends on the torque at refusal, whether higher torque is available (by bringing in another machine for instance), the depth at refusal, possible soil stratification, and anchor availability.

Again, take the easy case first. If the top helix is at least five diameters (that is, a distance equal to five times its own diameter) below the ground surface, three diameters into the current soil stratum, and three diameters below the level of seasonal change in soil properties, and the installation torque was above the minimum required to achieve the desired load capacity during the final three diameters of penetration, consider leaving well even though the rod or shaft may be sticking further out of the ground than desired. Replacing the top rod or shaft section, even if it requires some digging, may be better than the other alternatives.

If on the other hand, the installation does not meet all of the above criteria, things can get pretty sticky. If the torque you attained was 75% or less of the anchor's torque rating, bringing in higher-torque equipment is worth considering. Otherwise you run the risk of bringing in the new equipment and getting another foot or two of penetration, then having to shut down to keep from over-torquing the anchor.

If bringing in a higher-torque machine is not feasible, consider predrilling. Particularly on round-shaft anchors, predrilling a hole slightly larger than the shaft size can significantly reduce installation torque with little affect on axial capacity. This approach is not as useful with anchors subjected to lateral loads, however, because lateral capacity and stiffness may be reduced.



*Operator and groundworker working together are critical to a successful anchor installation. PISA® 4 anchor shown below.*



Again, if you do predrill, be sure to drive the top helix at least five diameters below the predrilled depth.

If the soil contains obstructions, it is possible that the anchor just got “hung up” on something. Often it is possible to back up and then work your way past the obstruction. In this case, as in the previous one of anchor breakage, it is better to use more, smaller helices than fewer, larger ones, and a curved leading edge on the anchor can be very useful.

If none of the previous suggestions does the trick, contact your Chance representative. In some limited situations we may be able to recommend a larger anchor which can develop the required load capacity at a lower torque. Otherwise, we will help you select an alternate type of anchor for the job.

Even if you manage to get past all the previously mentioned pitfalls, there is still more criterion for success. The anchor has to hold the load you designed it for.



Installation torque can be an excellent indication of anchor load capacity, if you follow the rules. Otherwise, it can be misleading. Basically, it is an indication of the effort necessary to compress and shear the soil around the anchor to allow penetration.

Load capacity, of course, is also a measure of the effort necessary to compress and shear the soil, so it should come as no surprise that the former can be used to predict the latter. One major difference between the two which must be taken into account, though, is that only the soil in the immediate vicinity of the helices affects their installation torque, while their load capacity is affected by a much larger volume of soil located either above, for tension anchors, or below, for compression anchors. This is why we recommend that installation torque values over the final three diameters of penetration be averaged to determine load capacity. If only the final torque is used, a tension anchor which has just passed from a softer layer to a harder one will be overestimated because the softer soil above will not affect the helices torque but will affect their load capacity. Averaging torque is also important for compression anchors, but because compression capacity is affected by soil which lies below the anchor and has not had the opportunity to affect installation torque, unexpected results may still come.

An anchor may fail to hold a given load for one of two reasons: Either



the anchor fails structurally or the soil fails around it. Sometimes an anchor failure is accompanied by a sudden movement of the shaft or rod and/or some audible indication. Other times it is not. Soil failures on the other hand, are usually recognizable by gradual movement of the shaft and absence of any audible indication (one exception being soil failure when the upper helix is less than three diameters deep, which is usually characterized by eruption of the soil at the surface).

One structural failure mode which occurs occasionally is bending of the helix under tension of compression loading. When this occurs, the answer is to use anchors with more helices to share the load or stronger ones to withstand the high stresses.

With PISA® anchors, the rod is often the weak link. Failure may occur by fracture, thread stripping,

or, if the application is controlled by deflection, rod yield. If a stronger rod is available, use it. If not, consider using an SS anchor.

With SS anchors, the weak link is normally the coupling bolt, although one does occasionally see the shaft split on its axis between the hole and the end if the bolt strength happens to be significantly above minimum.

Soil failure can be cured by using more or larger helices to spread the load out over a larger volume of soil. Soil failure and helix bending usually give the same indications at the surface, so it becomes necessary to recover the anchor and observe the helices to differentiate between them. However, it may not be possible to unscrew the anchor in such cases because the disturbed soil or bent helix cannot generate the necessary axial thrust. In such cases, use an anchor with more helices because this will cure either problem.

Remember, our experience indicates that 95 out of 100 Chance screw anchors are smoothly and successfully installed. The techniques we've shared with you can help you diagnose and solve any anchoring problems that you encounter and move you closer to the goal of a successful anchor installation.

# TOOLS MAINTENANCE

## Anchor tools require regular upkeep

**A**s with most mechanical devices, Chance anchor-installing tools periodically require maintenance checks to assure peak performance.

### TORQUE INDICATOR

In the case of the Shear-Pin Torque Limiter, (see drawing below or photograph at right) you should be able to rotate the tool shear halves independently from one another using a smooth-turning action. If rotation cannot be made by hand or if movement is rough, disassemble to check the thrust bearing, washers and pin for wear.

If the halves are dull, they need to be sharpened by surface grinding. A local machine shop can perform this service. When reassembling the indicator, coat thrust-bearing pin, washers and shear surface with grease.

Secure top shear half to the lower half by tightening the center bolt snugly. Back off one roll-pin slot



and lock with roll pins. Check cap screws for wear and replace if necessary. Torque cap screws to minimum of 60 ft.-lbs. All output string bolts used in the drive-train system should be checked for tightness. Loose or damaged bolts may fail at or below the anchor's torque rating and contribute to damage elsewhere within the tool assembly.

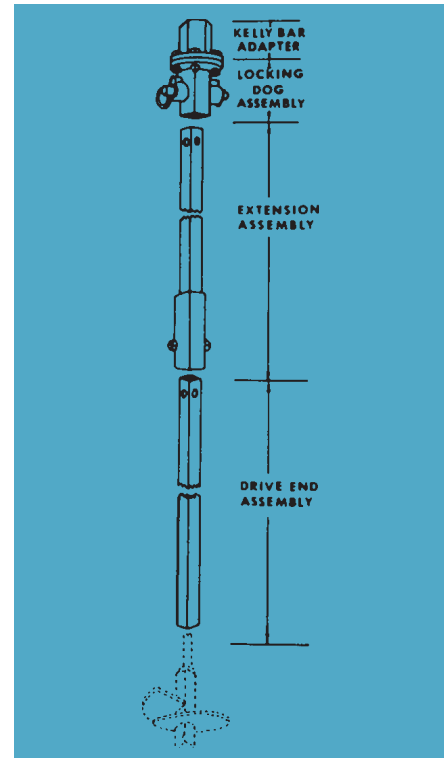

*When a torque indicator is used in the wrench system, it is positioned between the Kelly bar adapter and locking dog assembly.*

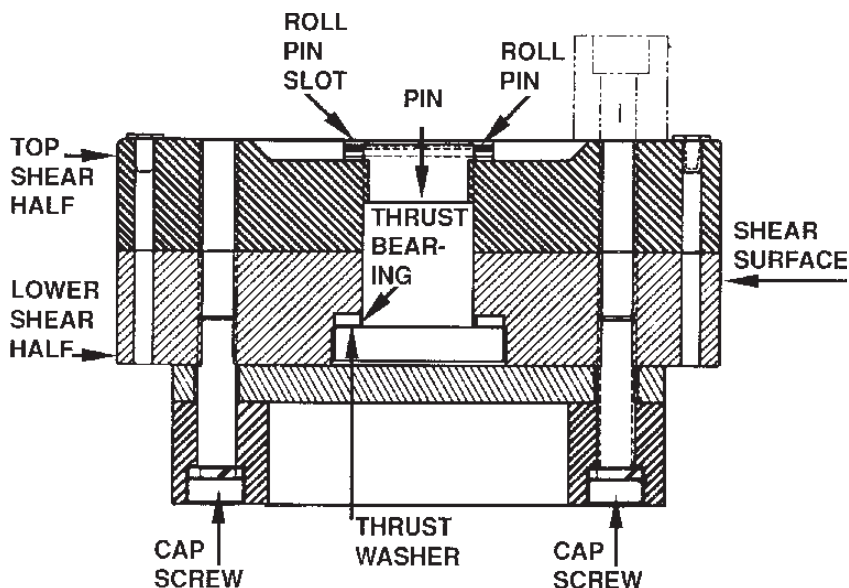

*Chance digital torque indicator uses no shear pins.*



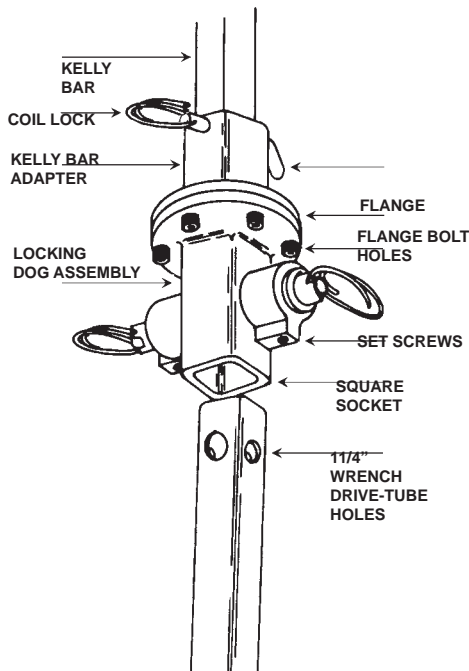

### LOCKING-DOG ASSEMBLY

The Chance Locking-Dog Assembly is another mechanical-anchor installing device that needs periodic inspection.

When the Locking-Dog Assembly is correctly positioned and in good working order, it performs smoothly and freely ensuring complete and positive capture of the anchor-installing wrench drive tube and anchor rod.

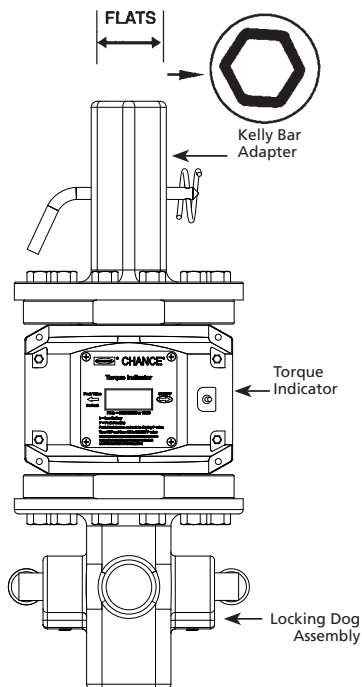
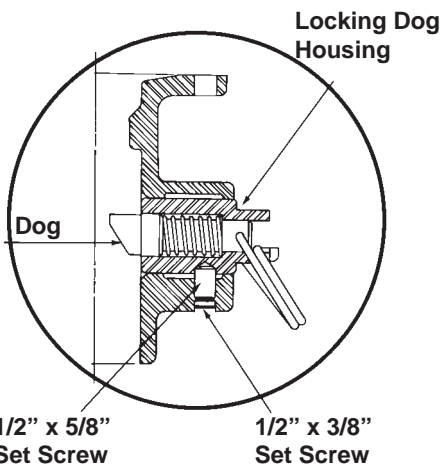

Figure 3



If locking dogs do not rotate smoothly or engage easily into the “in” and “out” positions, wrench and rod capture may not be correct. Under such circumstances, if dogs are worn or damaged, order new ones from Chance.

When inspecting the Locking-Dog Assembly, check to see (above) the set screws holding the two-dog assemblies are in position. There are two. One below each “dog.” The innermost set screw is  $\frac{1}{2} \times \frac{5}{8}$ ". The outermost screw is  $\frac{1}{2} \times \frac{3}{8}$ ".

Another portion of the Locking-Dog Assembly needing careful inspection is the square socket where the wrench drive tube is inserted (see photograph below). The socket can become worn from long-term use and/or poor wrench drive-tube alignment. Under such circumstances, the drive-tool end can become damaged. By monitoring the  $\frac{1}{8}$ " holes located at the top of the wrench-drive tube for wear, you can detect square socket wear that is beginning to damage the wrench. Drive tube wear at the  $\frac{1}{8}$ " holes shows the Locking-Dog Assembly is picking up torsional load on the wrench-drive wall inside the holes. Such wear indicates you need a new Locking-Dog Assembly.

*Notice square socket wear on the Locking-Dog Assembly in the photograph below.*

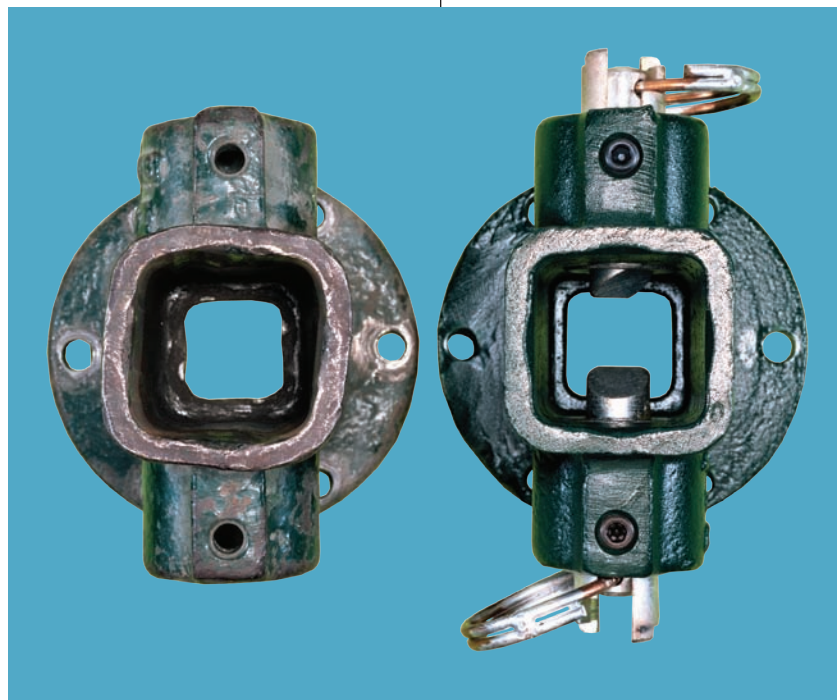

WORN

NEW

B



Photo 2

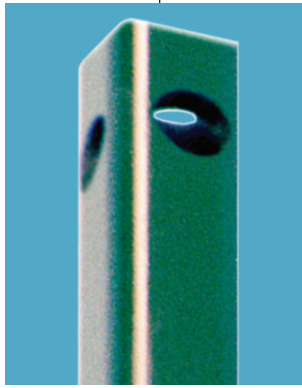

Photo 3

*Photo 2 shows drive tube damage resulting from poor wrench alignment during installation of anchors.*

*Photo 3 shows an undamaged drive tube.*

## KELLY-BAR ADAPTER

When ordering tooling for a new truck, the Kelly bar should be measured across the flats (see Figure 3 on pg. B-53) to establish the proper size between the truck Kelly bar and Chance Kelly-Bar Adapter.

Chance number P630012HD Kelly-bar adapter has a 2<sup>5</sup>/<sub>8</sub>" hex inside diameter. This particular adapter is often confused with a P630011HD Adapter with 2<sup>1</sup>/<sub>2</sub>" hex. If a P630012HD is used on a 2<sup>1</sup>/<sub>2</sub>" hex, the Kelly bar will tend



*Abused Kelly bar adapter hole elongation caused by the retaining pin picking up torsional load from the Kelly bar. This is an indication the hex shape of the Kelly bar adapter is being rounded off.*

to round out the hex socket of the Kelly bar adapter. In this case, the pin holding the Kelly bar adapter to the Kelly bar will begin to take up load and elongate the hole. This will eventually split-out the top of the Kelly bar adapter (see photograph below).

## RETAINING PIN

The Chance Retaining Pin (right) holds the Kelly bar adapter to the Kelly bar with a loose fit so the Retaining Pin will not take up load. The Pin consists of a bent arm and klik pin. This gives a positive connection at both ends of the pin to protect operators from accidental pin ejection due to drive-train torsional forces. Chance has a complete line of retaining pins to replace bolts previously used to secure tooling to anchor and Kelly bar adapter to Kelly bar. Retaining Pins



Unused Kelly Bar Adapter

are now included with all new Kelly bar adapters, square-shaft anchors and bumper-post installing tools.

Before any anchor installation, always check output bolts to ensure they are tight. Lost or damaged bolts can cause failure at or below the anchor torque rating or contribute to damage elsewhere on the output string. Check all tools and parts for wear or damage and replace as necessary.

## SUMMARY



During anchor installations maintain adequate down pressure and keep anchor-drive wrench in alignment with anchor to prevent uneven wear or damage to the tool. Misalignment puts an extremely high stress on the end of the wrench where the wrench fits over the anchor. This can possibly cause the drive tube to split on the end.

Check all tools and parts for wear or damage and replace as necessary. Order replacement parts from Chance. Properly used and with minimal service requirements, Chance tools will give extended service.



# ANCHOR TOOLING

## Safe, dependable

With the horsepower race for installing trucks and Power-Installed Screw Anchors (PISA®) increasing with each passing decade, anchor installing tools remain a very important part of the successful anchoring equation. Without the tools to handle the increased torque loads delivered by today's diggers, power-installed anchoring will literally grind to a halt.

Chance introduced the first PISA® anchor along with the tooling to install it in 1959. This 4,000 ft.-lb. (PISA® 4) anchor was followed by Chance 5,000 and 7,000 ft.-lb. anchors. The tempo of the anchor race to keep up with the increased capability of diggers and the demand of utilities to anchor in harder soils served as the catalyst for the 1980 Chance introduction of the 10,000 ft.-lb. hollow-hub SQUARE ONE® anchor.

For the decade of the '80s, the SQUARE ONE® anchor enabled utilities to anchor in soils they could only dream about penetrating with power-installed screw anchors during the previous decade.

With digger torque capabilities continuing to increase, Chance introduced the \*8,000 and 15,000 ft.-lb. TOUGH ONE® anchors with high-strength tooling in 1990.

Because the installed cost of PISA® anchors is substantially lower than "buried" anchors, and

*\*later increased to 10,000 ft.-lb.*

because utilities desire to install power anchors in harder soils, the trend toward heftier anchors and stronger tooling will continue. Digger trucks with 20,000 ft.-lb. of torque capability are not uncommon today.

**Digital torque indicator positioned between Kelly bar adapter and locking dog assembly.**



**BOLT SHEAR STRESS vs. INSTALLATION TORQUE**  
 10,000 FT.-LB. TOOLING  
 5-1/4 INCH BOLT CIRCLE

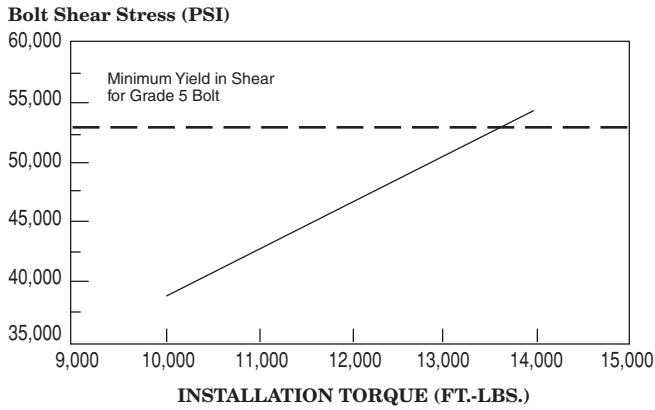

Based on SAE J429 Gr. 5 1/2" Bolts

Note: The shear strength for a Grade 5 bolt (52,400 psi) is reduced under the following conditions:

**BOLT SHEAR STRESS vs. INSTALLATION TORQUE**  
 15,000 FT.-LB. TOOLING  
 7-5/8 INCH BOLT CIRCLE

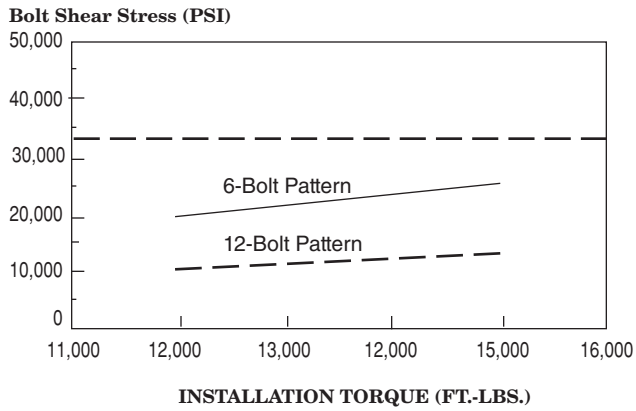

Based on SAE J429 Gr. 2 5/8" Bolts

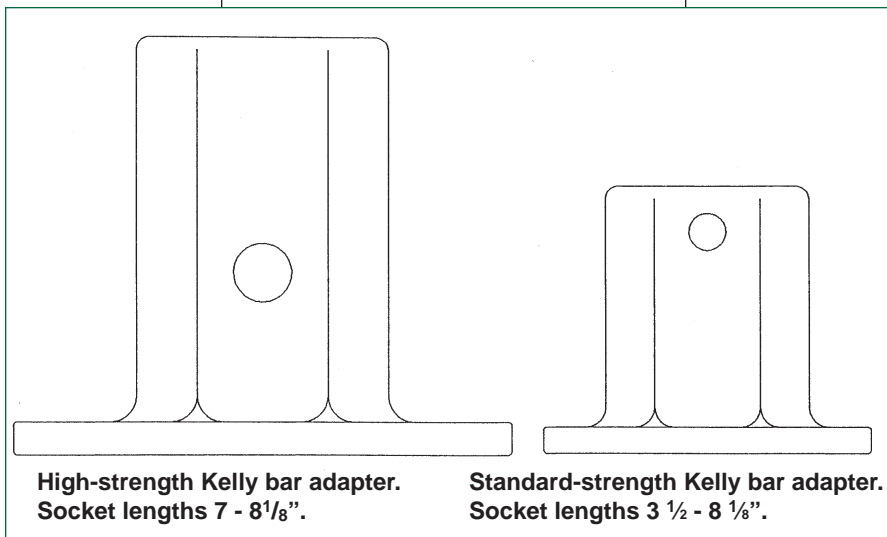

B



## High-Strength Tooling

Because of the forces impacting the tooling used to install high-strength PISA® anchors during installation, we have added features to ensure good performance and enhance safety.



Kelly Bar Adapter

Kelly bar adapter and locking dog assembly secured to the digger Kelly bar. Drive wrench is inserted into the locking dog assembly.

The Kelly bar adapter and locking dog assemblies both have  $7\frac{5}{8}$ " bolt circles. This compares to  $5\frac{1}{4}$ " circles on moderate-strength tooling. The larger circles put less stress on bolts during installation.



Locking Dog Assembly

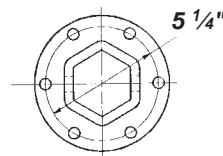

$5\frac{1}{4}$ " Bolt Circle on Standard-Strength Tooling (10,000 ft. lb.)

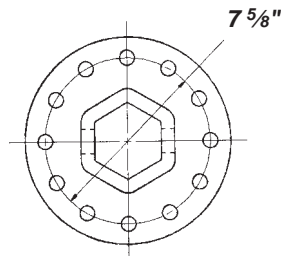

$7\frac{5}{8}$ " Bolt Circle on High-Strength Tooling (15,000 ft. lb.)

*Anchor tooling should not be torqued above its rating. Bolts should be regularly checked for tightness and wear.*

This helps allow installing torque to reach 15,000 ft.-lb. during demanding installations. If the bolts used to connect the Kelly bar adapter to the torque indicator or locking dog assembly are over-torqued, bolts can shear.

Our high-strength PISA® tooling has longer sockets on the Kelly bar adapters and locking-dog assemblies. This results in less wrench wobble during installation and reduces stress on bolts.

High-strength Kelly bar adapter and locking-dog assemblies are thicker and heavier to give added strength. The anchor-drive wrench is also thicker to give added fatigue life and increased torque strength.

### Proper Maintenance and Use of Tooling

Anchor installing tools require regular upkeep. All output string bolts used in the drive-train system should be checked for tightness. Loose or damaged bolts may fail at or below the anchor's torque rating and contribute to damage elsewhere within the tool assembly.

Lost or damaged bolts can cause

failure at or below the anchor torque rating or contribute to damage elsewhere on the output string.

Tools and parts should always be checked for wear or damage and parts should be replaced as necessary. Replacement parts should be ordered from Chance.

While checking all bolts of the tool output string, also check the set

screws of the locking-dog assembly. The two set screws (see below left) hold the two-dog assemblies in position. There is a screw below each "dog."

During anchor installation, keep anchor-drive wrench in alignment with anchor to prevent uneven wear or damage to the tool. Misalignment puts extremely high stress on the end of the wrench where the wrench fits over the anchor. This can possibly cause the drive tube to split on the end.

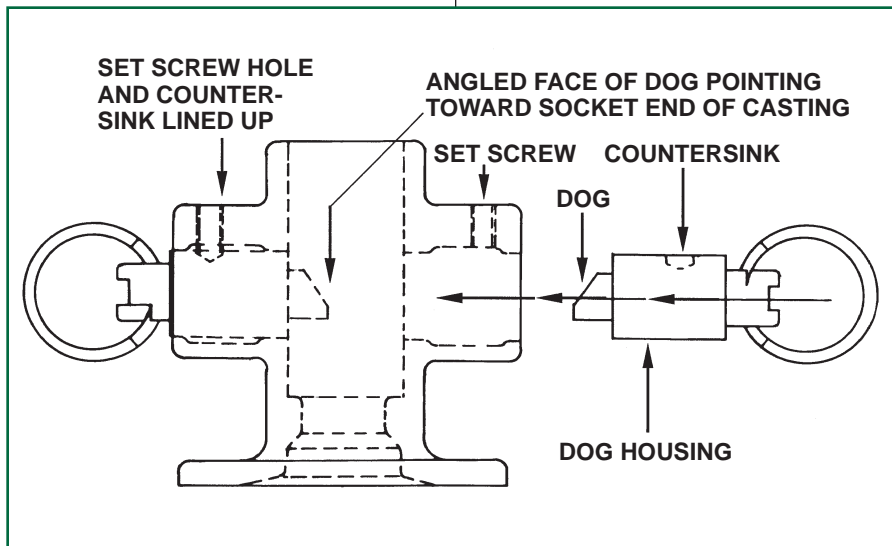
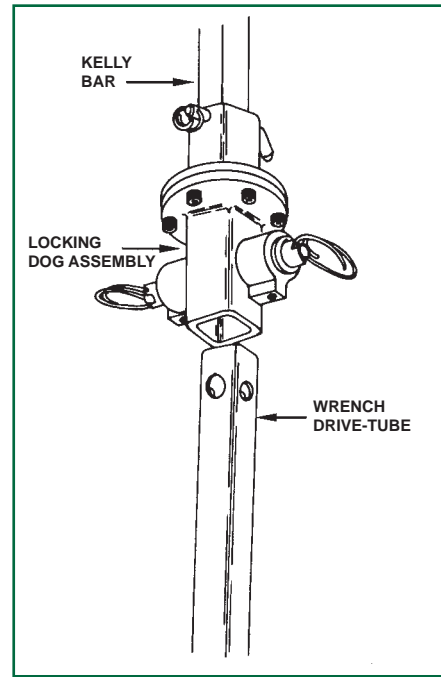
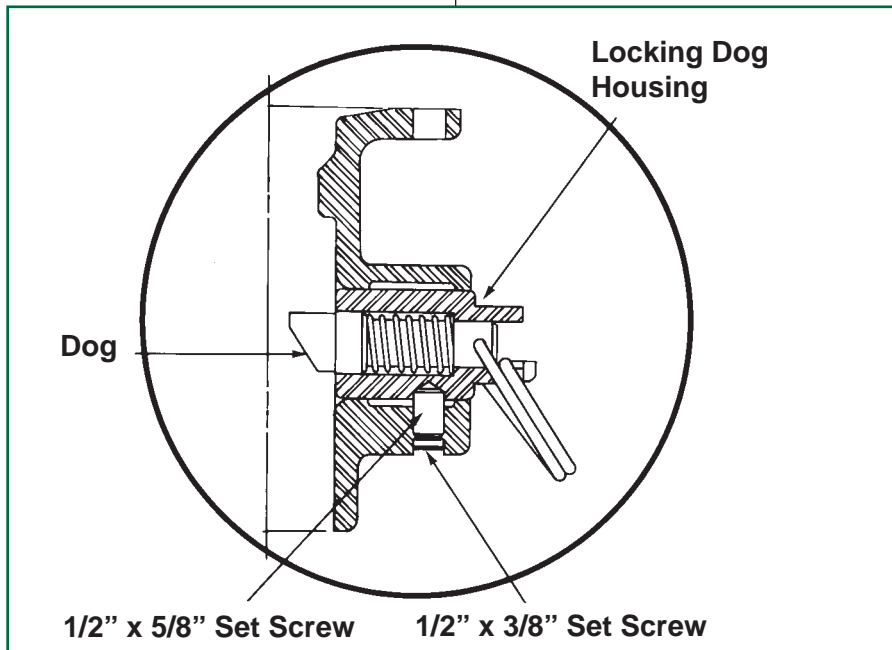

*In the middle position, the locking dogs hold the wrench drive tube. In the inside position, the locking dogs hold the anchor rod and drive tube.*

*Locking dog assembly components.*

# ANCHOR INSTALLING TOOL SAFETY

## Use proper tooling

**D**uring the installation of power-installed screw anchors (PISA®), it is essential to use installing tools and anchors that are properly rated for your trucks. Because of the high torque energy used in installing high-strength anchors with the new generation of trucks, the control of hazardous torque depends on several factors but especially proper tools.

### Use 15,000 ft.-lb. tooling when torque exceeds 10,000 ft.-lb.

Whenever anchor torque capacity and digger output capacity exceed 10,000 ft.-lb., use the 15,000 ft.-lb. Chance Tough One® anchor wrench assembly (see page B-28). This high-strength assembly is designed for today's anchors and installing trucks.



*Chance Mechanical Torque Indicator*

The locking dog assembly and Kelly bar adapter of the high-strength wrench assembly use a 7<sup>5</sup>/<sub>8</sub>" bolt circle with 5<sup>5</sup>/<sub>8</sub>" Grade 2 bolts compared to the 5<sup>1</sup>/<sub>4</sub>" bolt circle with 1<sup>1</sup>/<sub>2</sub>" Grade 5 bolts used on standard-strength 10,000 ft.-lb. tooling. The

larger bolt circle used in the high-strength tooling puts less stress on bolts and, in conjunction with the larger bolts that are used, allows installing torques to reach 15,000 ft.-lb. during demanding installations.



### Recommended Tightening Torques

1/2" Gr. 5	60 - 75 ft. - lb.
5/8" Gr. 2	76 - 95 ft. - lb.

*Do not use 10,000 and 15,000 ft.-lb. tooling above its rated performance strength.*

High-Strength PISA® tooling has a longer socket on the Kelly bar adapter and locking dog assembly. This results in less wrench wobble during installation and reduces stress on bolts. Both products are thicker and heavier than 10,000 ft.-lb. rated units, so there's greater strength. A thicker anchor-drive wrench gives added fatigue life and increased torque strength.

If a single installing tool component fails, the tremendous torsional energy transmitted by the tooling can be released violently. This sudden energy release can cause personal injury or property damage. That's why it is essential the proper anchor-installing tools be used, including not interchanging the installing tools of different manufacturers. Whether you use installing trucks with more than 10,000 or 15,000 ft.-lb. of installing torque capability, do not exceed anchor or tool ratings. To do so can stress the wrench system beyond its designed safe limit. Installing anchors beyond the safety limit will subject the wrench system and the operators to a hazardous condition.

### Chance tools made of ductile material

The selection of materials used in the manufacture of anchor tooling is very important. This is especially



*Note the difference in size of the 15,000 ft.-lb. wrench tube on the left compared to the 10,000 ft.-lb. standard tube on the right.*

true for the drive wrench portion of the tool assembly. Chance wrench tube design is based on the accumulation of more than 30 years of experience. The steel used to make wrenches is processed to achieve the right balance of hardness, strength, and toughness to stand up to the demanding chore of installing anchors.

Anchor wrenches can fail by applying torque above their rating. The opportunity for this to occur increases if the wrench is subjected to bending, shock loading due to rocks, or anchor breakage. Chance wrench tubes are designed to fail in a ductile manner. In other words, if the tube fails, it will fail in a manner that helps protect workers. Generally, it will twist along its length under conditions of failure.



*The 15,000 ft.-lb. high-strength wrench assembly is on the left. The standard-strength 10,000 ft.-lb. wrench is on the right.*

Wrench tubes can be processed to make them harder and stronger in an attempt to increase their torque rating. However, limitations in wrench cross-section geometry make this a potentially dangerous situation because it can cause the wrench to fail in a non-ductile or brittle manner. Brittle failures are dangerous to workers because the wrench tube can actually fracture into pieces and fly outward from the tool string.

Chance wrenches do not have this problem. They are processed to maintain ductility for a safe design.

Over time, all wrench system components will wear due to continued use. This is normal and should be monitored to establish a tool component replacement schedule.

Any worn bolts, pins and coil locks should be replaced with parts specified by Chance. We carefully select retaining pins and fasteners based on laboratory tests and field trials. Standard utility construction hardware is not acceptable for Chance anchor tool applications.

Using worn or damaged bolts, bent arm pins and coil locks can cause wrench system failures even when the tools are properly used. The important thing to remember is to refit tool components when required with the correct replacement parts found on pages B-25 through B-33.

### Types of standard tool stress above 10,000 ft.- lb.

**Wrench:** Above 10,000 ft.-lb. of torque, standard Chance Catalog Number C102-1583 wrench tubes will generally obtain a permanent twist along the length of the tube. However, rocky soil conditions can result in torque peaks well above 10,000 ft.-lb. This can violently split open the wrench end. This is especially true if the tool string is subjected to bending, or if the anchor being installed suddenly fails.

**Bolt Circle:** Bolt circle strength is a function of the diameter of the bolt circle, the diameter of the bolts, and the number and type of bolts used. Above 10,000 ft.-lb., the 5<sup>1</sup>/<sub>4</sub>" diameter bolt circle used to attach standard-strength wrench components is being stressed beyond its safe limit. If the applied torque continues to be above 10,000 ft.-lb., the bolts can fail in shear causing tools to violently separate as the torque energy is released. In addition, the sheared bolts can fly outward from the tool string.

**Adapter Failure:** Installing anchors above 10,000 ft.-lb. can also cause problems with Kelly bar adapters and locking dog assemblies, especially if the tools are subjected to bending. With the Kelly bar adapter, the hex socket can be enlarged or "lipped open." This will



If the bolts used to connect the Kelly bar adapter to the torque indicator or locking dog assembly are overtorqued, bolts can shear.

cause the bent arm pin attaching the Kelly bar adapter to the Kelly bar to transmit torque, something it was not designed to do. Torque on the pin can cause it to break, release torque energy and fly outward from the tool string.

Locking dog adapter sockets will also lip open or warp when the torque exceeds safe limits. This can cause many problems, the primary one being excessive force against the locking dogs and dog housing. Continued use of a damaged locking dog adapter causes the dogs and housing to wear away quickly. A worn locking dog can pre-

turely release an anchor, and rod when the operator is not expecting it. All of these potential failure modes apply as well to Chance high-strength tooling if used above 15,000 ft.-lb. of torque.

Chance anchor tooling is performance rated to provide safe, dependable use up to each tool's rated torque capacity. As a power-installed screw anchor user, your choice is simple. For anchoring up to 15,000 ft.-lb. use Chance high-strength 15,000 ft.-lb. tooling. For torques below 10,000 ft.-lb., use Chance standard-strength tooling.

**CHANCE<sup>®</sup>**

**ANCHOR  
TOOL**

**MAINTENANCE**

How to detect  
and  
help prevent  
damage to tooling.

*Kelly Bar Adapter continued . . .*



# KELLY BAR ADAPTER



## Elongation of Kelly bar holes.

**Cause** • The retaining pin carrying torque due to a worn Kelly bar or a worn or improperly sized Kelly bar adapter socket.

**Action:** • Replace the Kelly bar adapter. Make sure the new adapter is the proper size for Kelly bar. Replace worn Kelly bar.

B

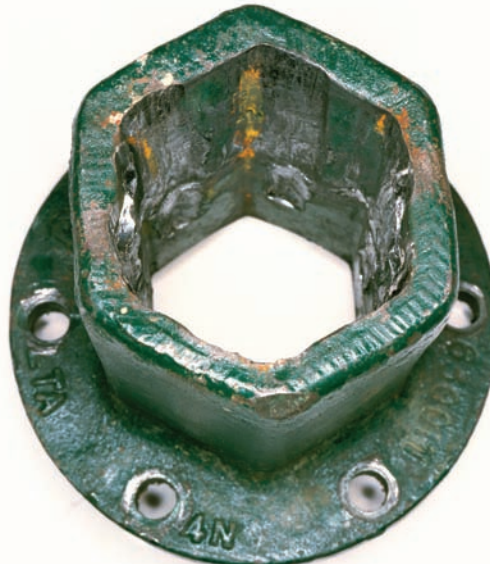

## Wear

**Cause** • Piloted Kelly bars.  
• Applied torque in excess of rating.  
• Worn Kelly bars.  
• Normal usage over long period of time or in obstruction-laden soils.  
• Side loading or tool misalignment during anchor installation.

**Action:** • Replace the Kelly bar adapter. Chance now sells only heavy duty Kelly bar adapters which last longer with piloted Kelly bars.  
• Avoid misalignment during anchor installation.  
• Replace worn Kelly bar.

*Kelly Bar Adapter continued . . .*

# KELLY BAR ADAPTER



## Retaining pins & coil locks

- Cause:**
- Normal usage over long period of time.
  - Worn Kelly bar or worn or improperly sized Kelly bar adapter or installing tool socket.
  - Use of wrong size retaining pin.
- Action:**
- Replace with proper size retaining pin and coil lock.
  - Replace worn Kelly bar or Kelly bar adapter or installing tool.

## Elongation of Flange Bolt Holes



- Cause:**
- Applied torque in excess of rating.
  - Failure to maintain proper bolt tightening torques.
- Action:**
- Replace the Kelly bar adapter.
  - Do not exceed tool's torque rating.
  - Keep bolts tightened to recommended torque.

# LOCKING DOG ASSEMBLY

## Square Socket Wear

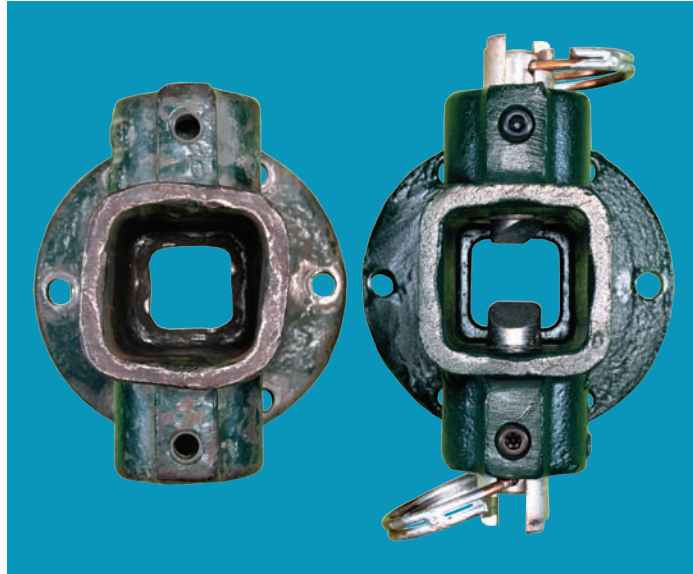

- Cause**
- Normal usage over long time.
  - Applied torque in excess of rating.
  - Side loading or tool misalignment during anchor installation.
- Action:**
- Replace locking dog assembly (may also be necessary to replace drive tube).
  - Do not exceed tool's torque rating.
  - Maintain proper alignment during anchor installation.

## Elongation of Flange Bolt Holes



- Cause:**
- Applied torque in excess of rating.
  - Failure to maintain proper bolt tightening torques.
- Action:**
- Replace the locking dog assembly.
  - Do not exceed tool's torque rating.
  - Keep bolts tightened to recommended torque.

Locking Dog Assembly continued . . .

# LOCKING DOG ASSEMBLY

B

## Loose Dogs

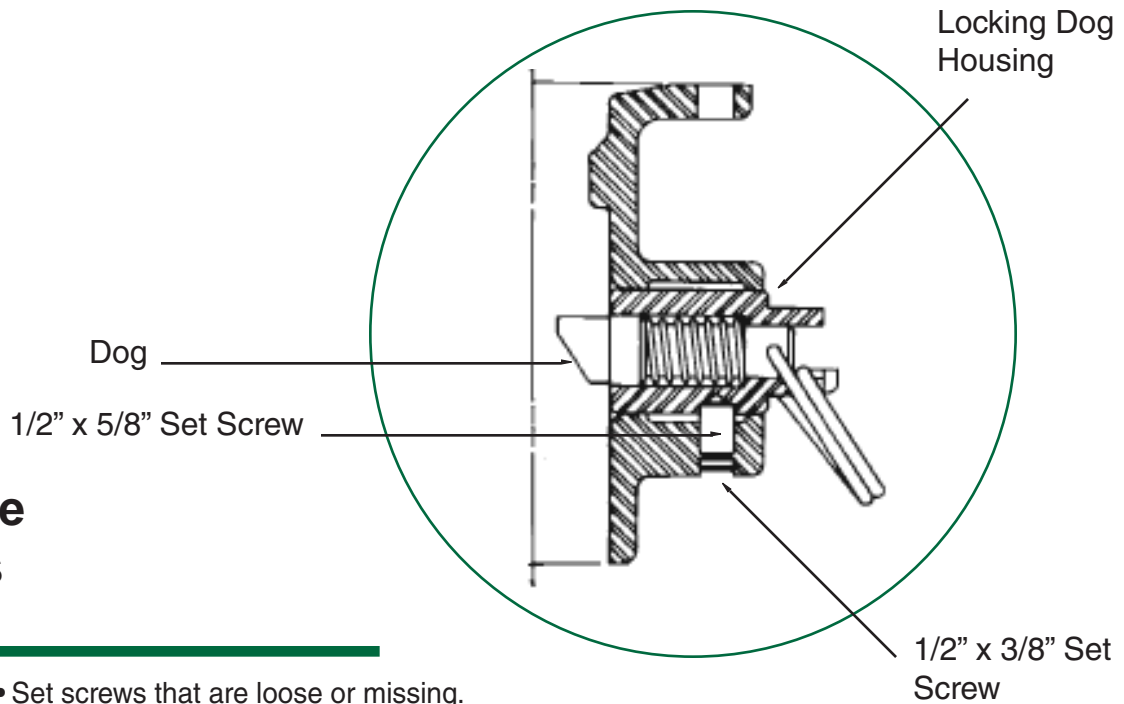

**Cause** • Set screws that are loose or missing.

**Action:** • Remove and replace set screws using replacement kit.

## Worn/Cracked Dogs or Dog Housings

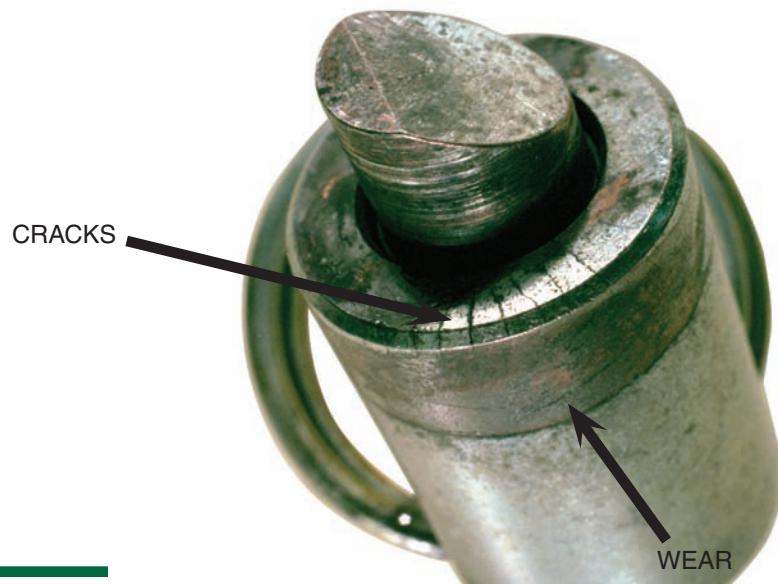

**Cause** • Worn locking dog assembly socket.  
• Drive tube wear.

**Effect:** • Dog assemblies share torsional load.

**Action:** • Inspect locking dog adapter and wrench tube and replace as necessary.

• If locking dog adapter is ok, replace dog assemblies using replacement kit in catalog.

*Locking Dog Assembly continued . . .*

# LOCKING DOG ASSEMBLY

## Flange Bolts



- Cause**
- Wrong grade bolts.
  - Applied torque in excess of rating.
  - Failure to maintain proper bolt tightening torques.
- Action:**
- Replace with proper size and grade bolts.
  - Do not exceed tool's torque rating.
  - Keep bolts tightened to recommended torque.

B

# DRIVE TUBE

## Elongation of Drive Tube Holes



- Cause**
- Worn locking dog assembly socket.
  - Worn drive tube.
- Action:**
- Replace drive tube.
  - Check locking dog assembly - replace if worn.

# DRIVE TUBE



## Twist

- Cause:**
- Torque in excess of rating.
- Action:**
- Replace drive tube.
  - Do not exceed tube's torque rating.

## Dog End of Tube Twisted Off



- Cause**
- Extremely worn locking dog adapter.
  - Insufficient engagement of tube in locking dog adapter.
- Action:**
- Replace drive tube.
  - Check locking dog assembly - replace if worn.
  - Be sure tube is captured in locking dog adapter by dogs before using.

## Split or Broken Drive End

- Cause**
- Torque in excess of rating.
  - Inadequate engagement of anchor in tube.
- Action:**
- Replace drive tube.
  - Do not exceed tube's torque rating.
  - Maintain full engagement with anchor at all times.

